



ELOTECH
INDUSTRIELELEKTRONIK GMBH



Format, case: 96 x 96 mm (1/4 DIN)
Format, face plate: 98 x 98 mm
Installation depth: 122 mm

4-, 6-, 8- Zones Two-point (heat-only) Temperature Controller with LCD-Display

R2400

Option: Heater current monitoring
Option: CANopen interface
Option: Profibus DP interface
Option: Ser. Interface RS232, RS485

DESCRIPTION AND OPERATING MANUAL

3. Connection Diagram: R2400-421, R2400-621, R2400-821

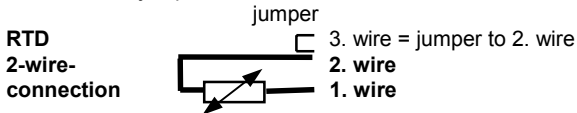
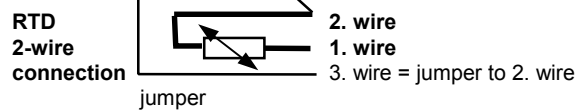
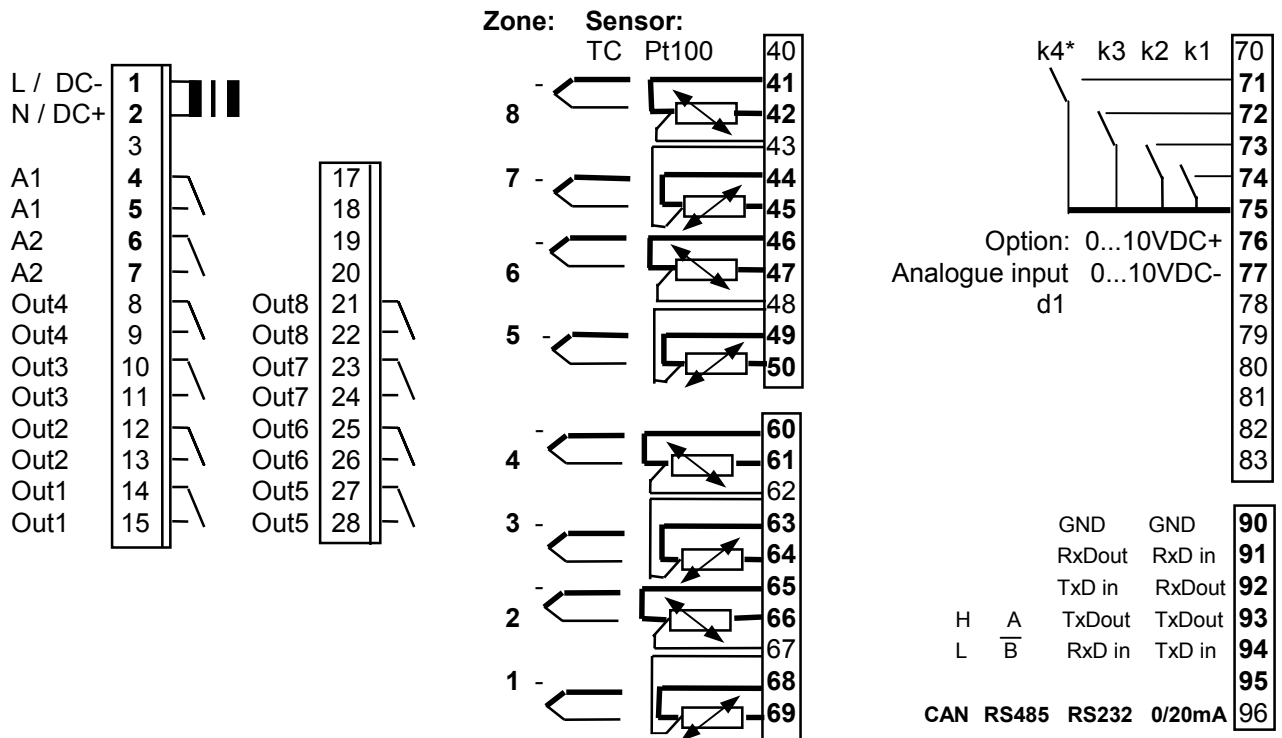

Control output OUT 1: Zone 1; control output „heating“ or „cooling“, relay to

Control output OUT 8: Zone 8; control output „heating“ or „cooling“, relay

Alarm Output A1: Alarm 1 (Temperature-monitoring alarm A1 for all zones)
Alarm Output A2: Alarm 2 (Temperature-monitoring alarm A2 for all zones)

Analogue input d1: 0... 10 VDC, OPTION Zone: d1

Setpoint Controlling: K1: open = Setpoint 1 (SP1) valid
 K1: closed = Setpoint 2 (SP2) valid, for all zones

Adjustment lock (LOC): K2: open = Adjustment lock only via „software code“
 K2: closed = Adjustment locked according to the chosen „software code“.

Setpoint changing: K3: open = individual setpoint adjustment for each zone
 K3: closed = if setpoint has been changed in one zone, this new setpoint is valid (will be overtaken) for all other zones automatically.

CAN-Interface: K4: open = CAN: „operational“. Operation only with CANopen protocoll.
 K4: closed = CAN: „operational“ always active.
 *) „K4“ must be closed, if the instrument is equipped with a CAN-interface but not used.

5. Display and Keyboard, general

The device is equipped with a LCD-display.

After switching on and initialising the device, the actual process values of all connected controller zones are displayed.

Zone-no.: 1

Process value: 200°

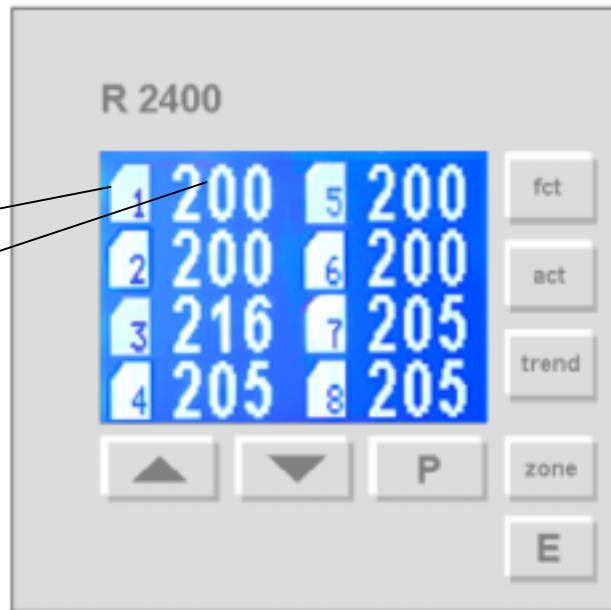

4-zones controller:
 PROCESS- and SETPOINT VALUES are displayed simultaneously.
 Left: actual process value
 Right: setpoint

Most of the individual parameters of the device are displayed in plain text either in english or in german. See chapter 6: Device Configuration (press keys „E“ and „P“ simultaneously for appr. 3 seconds).

Key functions:



Select individual zone. **Zone Information.**
 Actual process value and setpoint value display of the selected zone.



Parameter key (parameter preselection of the selected zone).



Adjustment of selected parameter (e.g setpoint or control parameters) to higher values. When the parameter adjustments have been altered but not entered, a flashing „ E “ will be shown in the display.



Adjustment of selected parameter (e.g setpoint or control parameters) to higher values. When the parameter adjustments have been altered but not entered, a flashing „ E “ will be shown in the display.



Confirmation and storage of the preselected parameter values.
 E = Enter.



Tendency display will be selected. This will give an overview about all connected controller zones and the deviations between setpoint and process value. Simultaneous a zone dependent alarm signalisation will be shown.



Display of **all actual process values of the connected controller zones.**



Recorder function. Display of actual value path over time. First select individual zone with key „zone“. Then press „fct“. To switch off the recorder function: press „fct“ again.

Contrast setting:

Press „E“ and keys „▲“ or „▼“ simultaneously.

5.1 Displays

Taste **act** : **Display of all actual process values of the connected controller zones.**

4-zones controllers: PROCESS- and SETPOINT VALUES are displayed simultaneously.



Warning Er.H :
Measurement range exceeded or sensor fault

Warning Er.L :
Measurement range undershot or sensor short circuit

No indication:
Respective control zone is switched off.

Select a single zone :
Select tendency display:

Press key „ **zone** “
Press key „ **trend** “

Taste **zone** : **Zone Information.**
Display of process value, setpoint and alarm signalisation of one special zone.



Adjust the setpoint with
keys „ ▲ “ and „ ▼ “.

When the parameter adjustments have been altered but not entered, a flashing „ E “ will be shown in the display. Enter the adjusted value with key „ E “.

SET: Setpoint 1 active
SET SP2: Setpoint 2 active
MANUAL: Actuator mode.

Adjustment of setpoint 2:
See: Level „Control Parameters“ chap. 8.

Further displays:

- Actual output ratio (%):
This shows the momentary calculated ratio. It can't be altered. The display is in percent of the installed performance capability for heating or cooling.
Negative values: „cooling“
„*“ behind the percent value: Control output „on“
- Heater current indication in amps., if this option is installed and configured.
- Alarm indications: alarm active, e.g.: A2 
- Status indications: Autotune active: OPT
Ramp function active: RAMP
Warnings: E. xx

Select other controller zone:
Select recorder function for this zone:
Select tendency display:

Press key „ **zone** “
Press key „ **fct** “
Press key „ **trend** “

Taste **trend** : Temperature Tendency- and Alarm display



This function shows the temperature trend and alarm status of outputs A1 and A2.

This display allows a rapid overview of the temperature conditions of the control zones connected.

- ▬ : Positive or negative temperature deviation between setpoint and actual temperature value: $\leq 1\%$ of measurement range
- : Positive or negative temperature deviation between setpoint and actual temperature value: $1,5\%$ of measurement range
- : Positive or negative temperature deviation between setpoint and actual temperature value: $\geq 3\%$ of measurement range

Line A1: if alarm A1 is active, indication „“ is displayed under the respective zone-no.
Line A2: if alarm A2 is active, indication „“ is displayed under the respective zone-no.

If the option "Heater current monitoring" is active and if a continuous current flow has been determined (failure of the semiconductor switches) then the following message is reported: "Current failure alarm".

Select further zone: Press key „ **zone** “
Select all actual values: Press key „ **act** “

Taste **fct** : Recorder function



Display of actual value path over time.

Select with key „**zone**“ the „zone information“ - display of a wished zone and press key „**fct**“.

The time axis is defined by the "Sample time" (see chap. 6).

This function enables the user to observe the transient response and the timing behaviour of the controller for the respective control zone without the need for any additional devices and to parameterise these accordingly.

In the event of a fault, the course taken by the actual value within a given period of time can be retrospectively examined prior to the occurrence of the fault.

The actual value is always displayed symmetrically around the current setpoint.
Above key „ **P** “ : Indication of the actual process value.

Taste „**▲**“ : Decrease cutout based on current setpoint. Precise display.
Taste „**▼**“ : Enlarge cutout based on current setpoint. Approximate display.





Return to zone indication and leave the recorder function: Press key „ **fct** “.

The selected configuration is effective for all control zones (collector contact).
 The individual alarms A1 of all zones are connected to the main, common contact A1.
 The individual alarms A2 of all zones are connected to the main, common contact A2.
 The individual selected alarm configuration of A1 and A2 is valid for all active controller zones.
 The alarm values itself (switching points) have to be set for each zone in the parameter level „Control Parameters“ individual.

Please note:

Care should be used to ensure, that the setpoints of the alarm contacts are programmed within the selected measuring range. If a setpoint ramp has been programmed, the alarms that are relative to the setpoint (signal contact, limit comparator) follow the setpoint up the ramp.
 In case of sensor error the alarms will react in the same way as range override.
 The alarm contacts therefore do not offer protection against all types of plant breakdown.
 With this in mind, we recommend the use of a second, independent monitor unit.

Alarm A1: Configuration (switches relay A1)	Alarm off, no alarm signalisation	conf.no.:	co.0	(ex works)
	Signal contact, setpoint dependent:	low - high	co.1	
	Limit contact, process value dependent:	low - high	co.2	
	Limitcomparator, setpoint dependent:	low - high - low	co.3	
	Signal contact, setpoint dependent:	high - low	co.4	
	Limit contact, process value dependent:	high - low	co.5	
	Limitcomparator, setpoint dependent:	high - low - high	co.6	
	Limitcomparator, with start-up suppression:	low - high - low	co.7	
	Heater current monitoring; limit contact:	low - high	co.8	
Heater current monitoring; limit contact:	high - low	co.9		

Alarm A1: Relay switching behaviour	Direct	if alarm signalisation  on:	then the relay contact is closed	(ex works)
		if alarm signalisation  off:	then the relay contact is open	
	Inverse	if alarm signalisation  on:	then the relay contact is open	
		if alarm signalisation  off:	then the relay contact is closed	

Alarm A2: Configuration (switches relay A2)	Alarm off, no alarm signalisation	conf.no.:	co.0	(ex works)
	Signal contact, setpoint dependent:	low - high	co.1	
	Limit contact, process value dependent:	low - high	co.2	
	Limitcomparator, setpoint dependent:	low - high - low	co.3	
	Signal contact, setpoint dependent:	high - low	co.4	
	Limit contact, process value dependent:	high - low	co.5	
	Limitcomparator, setpoint dependent:	high - low - high	co.6	
	Limitcomparator, with start-up suppression:	low - high - low	co.7	
	Heater current monitoring; limit contact:	low - high	co.8	
Heater current monitoring; limit contact:	high - low	co.9		

Alarm A2: Relay switching behaviour	Direct	if alarm signalisation  on:	then the relay contact is closed	(ex works)
		if alarm signalisation  off:	then the relay contact is open	
	Inverse	if alarm signalisation  on:	then the relay contact is open	
		if alarm signalisation  off:	then the relay contact is closed	

Heater current monitoring (Option)

The heater current monitoring function is valid for all connected control zones if selected.

The following parameters will only be displayed if the heater current monitoring system is activated as described below:



Heater current monitoring via relay A1: Set parameter „Alarm A1: Configuration“ to configuration. no. co.8 or co.9

Heater current monitoring via relay A2: Set parameter „Alarm A2: Configuration“ to configuration. no. co.8 or co.9

The heater current to be monitored, has to be programmed as an absolute value for relay A1 or relay A2.

First select zone. Then select alarm value A1 or alarm value A2 and adjust the heater current value (ampere).

Heater current, actual value: Select zone (zone information). Heater current display: see „current“ (ampere)

Heater current, alarm signalisation: Zone information: A1  or A2 

Tendency display:  or  to the zone concerned

Please note:

If the supply voltage is low, the heater current has to be higher than the monitoring value. Otherwise the alarm signal will be activated.

If the heater current value falls below the monitoring value, an alarm signal (the relay switches) will be activated.

With the help of the parameter „Delay time“ it is possible to program a delay time for this.

When switching the power-on, the alarm signalisation will be suppressed until the heating current values for all zones has been scanned and verified.

Current detection cycle time (sec.) 1 ... 60 sec. Time between the current measured of two zones following each other. (ex works: 2 secs.)

Alarm A1: Delay time (sec.) 5 steps adjustable (in sec.) Adjustment and display in seconds. off= no delay time The values are dependent on the current detection cycle time and the number of active controller zones. If alarm relay A1 is configured for heater current monitoring.

Alarm A2: Delay time (sec.) 5 steps adjustable (in sec.) Adjustment and display in seconds. off= no delay time The values are dependent on the current detection cycle time and the number of active controller zones. If alarm relay A2 is configured for heater current monitoring.

Leakage current Min. limit value off; 0,0...99,9 A Adjustment of the allowed min. leakage current value.

SSR's (especially if they are combined with RC-combinations) normally have small leakage currents.

The sum of the actual leakage current will be displayed as „act. leakage current“.

If a permanent current is detected the alarm relay will be activated.

The status will be displayed as follows:

See „Zone information“: „Er.Cu“ (Error Current) flashes

See „Tendency display“: „Permanent current“

The zone with a permanent current only can be detected by observing the actual temperate process values (high values).

Technical data: Heater current monitoring

Current transformer 1:1000: Passive through current transformer with snap-in attachment for DIN rail mounting (Type M2000) (EN 50022, 35mm). Connections to the controller: 2 x 6,3mm flat connectors.

Heater current detection and indication range: 0...max. 60,0A. Single-phase operation. 0...max. 99,9 A. Three-phase operation. The sum of the current of all three phases of one controller zone will be monitored. Variations of the power supply voltage have to be considered when the alarm values are programmed.

Adjustment lock

- All parameters adjustable (others are locked) (ex works)
- Only setpoint 1 adjustable
- Setpoints, alarm values and ramps adjustable
- All parameters locked

The parameters that have been locked, can be displayed but not altered.
This adjustment can't be changed, if the external contact K2 is closed.

Zones offset

(Continuous numbering of the controller zones if more than 1 device is used)

off; 1 - 91

Zones will be numbered with a preselected offset value.
(ex works: off)

Examples: offset =off: zones numbering: 1-4, 1-6, 1-8
offset =4: zones numbering: 5-8, 5-10, 5-12

The following parameters are only valid, if the unit is equipped with a serial interface.
RS232, RS485, 0/20mA.

Ser. Interface:
Protocol selection

- Standard ELOTECH protocol
- Gateway Valid for InterBus-S via gateway M-IBS-5
Only with RS 485-interface

Ser. Interface:
Device address

1 255 (ex works: 1)
The computer addresses the unit/controller at this address.
Each unit has its own address. With RS-485 it is possible to address 32 units.

Ser. Interface:
Data format

Data bit:	7	Parity:	even	Stop bit:	1	(ex works)
	7		odd		1	
	7		even		2	
	7		odd		2	
	7		no		2	
	8		even		1	
	8		odd		1	
	8		no		1	InterBus-S via gateway
	8		no		2	

Ser. Interface:
Baud rate

off; 300Baud ... 9,6 kBaud (ex works: 9,6)
The baud rate denotes the transmission rate at which one bit is transmitted.
InterBus-S-Gateway = 9,6 kBaud

See:

- sep. interface description: ELOTECH – standard-protocol
- sep. interface description: Gateway: M-IBS-5
- Chapter 8.2

The following parameters are only valid, if the unit is equipped with a **CANopen interface**.

CANopen: Device adress	1 127	(ex works: 1)
CANopen: Baud rate	10k, 20k, 50k, 100k, 125k, 250k, 500k, 1000k Baud	(ex works: 20)
CANopen-specification:	CANopen Master: no CANopen Slave: yes Extended Boot-up: no Minimum Boot-up: yes COB ID Distribution: yes; default via SDO Node ID Distribution: no; via device keyboard No. of POD's: 0RX, 1TX PDO Modes: async. Variable PDO mapping: no Emergency message: yes Life guarding: yes No. of SDO's: 1RX, 1TX Device Profile: CiA DS-404	
See:	-ELOTECH Object Dictionary -ELOTECH Shortform Object Dictionary; Multizones controller -CiA CANopen Device Profile DS-404 -Chapter 8.1	

The following parameters are only valid, if the unit is equipped with a **PROFIBUS DP – interface**.

PROFIBUS DP:	off	Profibus: read only Controller operation via the keyboard is possible.
Remote	on	Profibus: read / write It is only possible to programm and operate the controller via the Profibus DP – interface (no operation via keyboard).
PROFIBUS DP: Device adress	1 125	(ex works: 1)
PROFIBUS DP: Baud rate	The baud rate will be detected and displayed automatically. It is not adjustable.	
	not detected 12 MBaud 6 MBaud 3 MBaud 1,5 MBaud 500 kBaud 187,5 kBaud 93,75 kBaud 45,45 kBaud 19,2 kBaud (will not be supported) 9,6 kBaud (will not be supported)	
See:	-ELOTECH - Profibus DP description -Chapter 8.3	

Recorder function: Sample time	2,5sec. ... 10min.	See: Recorder function (Chapter 5.1) Adjustment of the time difference between two temperature values. The total time, which can be monitored, will be displayed. Note: The sample time has to be shorter than the fastest changings of the actual temperature. It is possible to store up to 90 temperature values.
---	--------------------	--

Device code: EL.xx

End of this parameter level.
Next Display: „Language / Sprache“

7. Parameter Level: Zone Configuration

Adjustable for each controller zone individually.

This zone dependent parameters have to be set after programming the device configuration.

Select individual zone with key „zone“.

Press keys „P“ and „E“ simultaneously appr. 3 seconds. The first parameter is „Zone on/off“.

Adjust this parameter with keys „▲“ and „▼“ and confirm it with the „E“-key. Press key „P“ to select the next parameter.

If there is not operation within appr. 30 seconds, the display will return to „zone information“ (actual value- and setpoint- display) of the selected zone.

If you want to leave this level: press key „E“ appr. 3 seconds.

Zone on/off	on	Measuring- or controller zone activ	(ex works)
	off	Measuring- or controller zone switched off	
Controller configuration	2-point controller "heating-off"		(ex works)
	2-point controller "cooling-off"		
	2-point controller „cooling non linear“	Cooling action can be pre-selected with either linear or non-linear cooling response curve (e.g. for vapour cooling).	
	Indicator, no controller action		
Sensor selection	PT100 (RTD),	- 50,0 ... 100,0 °C	
	PT100 (RTD),	- 58 ... 212 °F	
	PT100 (RTD),	- 90,0 ... 205,0 °C	
	PT100 (RTD),	-130 ... 401 °F	
	PT100 (RTD),	0 ... 400 °C	(ex works)
	PT100 (RTD),	32 ... 752 °F	
	PT100 (RTD),	0 ... 800 °C	
	PT100 (RTD),	32 ... 1472 °F	
	or, if thermocouple has been selected (see chapt. 6: „sensor mix“)		
	TC Type L, FeCu-Ni	0 ... 400 °C	
	TC Type L, FeCu-Ni	32 ... 752 °F	
	TC Type L, FeCu-Ni	0 ... 800 °C	
	TC Type L, FeCu-Ni	32 ... 1472 °F	
	TC Type J,	0 ... 800 °C	
	TC Type J,	32 ... 1472 °F	
	TC Type K, Ni-CrNi	0 ... 1200 °C	
	TC Type K, Ni-CrNi	32 ... 2192 °F	
	TC Type S, Pt10Rh-Pt	0 ... 1600 °C	
	TC Type S, Pt10Rh-Pt	32 ... 2912 °F	
	Take care:		
	If the Sensor selection is changed, the following parameters will be set as follows and need to be readjusted:		
	Setpoint 1, Setpoint 2:	Setpoint limitation min.	
	Lower setpoint limitation:	Bottom range end	
	Higher setpoint limitation:	Top range end	
	Setpoint-ramp values:	off	
	Alarm values:	off	
	Process value offset:	off	
Process offset	-999... off... 1000 °C/°F		(ex works: off)
	-9,9... off... 10,0 °C/°F		
	This parameter serves to correct the input signal, e.g. for:		
	- the correction of a gradient between the measuring point and the sensor tip,		
	- the line resistance balancing of 2-line RTD (Pt100) sensors and		
	- correction of the control deviation when using P- or PD-action.		
	If for example the offset value is set to +5°C, then the real temperature measured by the sensor (when process is balanced) is 5°C less than the setpoint and the displayed process value.		
Setpoint limitation: max. setpoint	Highest adjustable setpoint value		(ex works: 400°C)
	programming range: setpoint limitation min. ... top range		
Setpoint limitation: min. setpoint	Lowest adjustable setpoint value		(ex works: 0°C)
	programming range: bottom range ... setpoint limitation max.		

**Softstart-function,
general**

If you select the softstart-function, make sure that the instrument is equipped with bistable voltage (logic) outputs. This function is not allowed for instruments with relay-outputs. Otherwise the relays will be damaged.

Softstart (general description):

During the softstart the controllers' heating output response is limited to a pre-selected ratio, in order to achieve a slow baking out of high performance heat cartridges. This results in a slower, more regular heating period. Simultaneously the output clock frequency is quadrupled. For this purpose the bistable voltage output must be taken, that actuates SSR relays.

Once the process value reaches the softstart setpoint, it remains stable at this value for a pre-selected hold-duration time. At the end of this period the process value rises to the valid setpoint.

If the softstart is active, the controllers' autotune function can't operate (E.OP). If a setpoint-ramp has been programmed, the softstart has priority, and the ramp will only become active after the softstart has been completed.

The softstart only works,

- if the parameter „Proportional-band“ is programmed $\geq 0,1\%$.
- if the actual process value is lower than softstart-setpoint $- 5\%$ of the selected measuring range.

It is possible, to select this function for each zone individually.

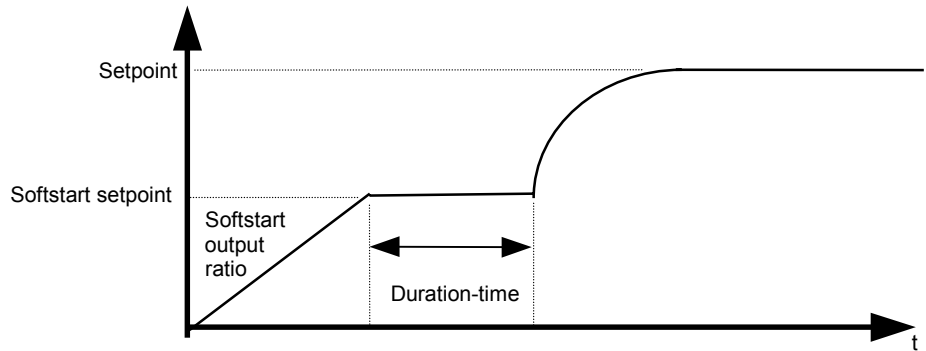

**Softstart:
on / off**

- off: Softstart function not active (ex works)
- Other softstart-parameters are not shown.
- on: Softstart function in action.
The softstart function always runs, if the controller is switched on and / or if the actual temperature is below the softstart setpoint minus 5% of the range (e.g. range: 400°C -> 5%= 20°C).
Adjust the following parameters:

**Softstart:
output ratio
(%)**

10 ... 100% (ex works: 30)

**Softstart:
setpoint**

range: setpoint min. setpoint max. (ex works: 100)

**Softstart:
duration time
(min.)**

off; 0,1 ... 10,0 min. (ex works: 2,0)

Output mode

Controller mode.

(ex works)

Actuator mode

AUTOMATIC
the

In event of sensor break the controller automatically maintains the last valid output ratio as the actuating signal.

Select display: Zone information with key „zone “
PROCESS: Error warning: Er.H or Er.L.
MANUAL: The actual output ratio is shown.
This ratio can be manually altered (like a setpoint).
Use keys „▲ “ and „▼ “. Confirm it with the „E “-key.

Under the following circumstances, the output ratio will be 0%:

- if the output ratio at time of the sensor break was 100%.
- if the controller is working along a setpoint-ramp.
- if the control deviation was more than 0,25% of the total range at the time of sensor break.
- if the Proportional-band (P) = off.
- if the softstart was active at the time of the sensor break.

A few seconds after the sensor break has been rectified, the controller returns to automatic operation and calculates the required output ratio.

An additional signal can be issued in the event of sensor break, if the alarm contacts are programmed accordingly.

Actuator mode

MANUAL

The controller now operates only as an actuator = manual mode.
The control function (PID) is out of work.

Select display: Zone information with key „zone “
PROCESS: Actual process value is shown.
MANUAL: The output ratio is shown.
This ratio can be manually altered (like a setpoint).
Use keys „▲ “ and „▼ “. Confirm it with the „E “-key.

Copy all parameters of this zone to

destination zone

The „Zone Configuration“ and the following controller-parameters (described in chap. 8), and programmed in this zone, can be copied to each other zone, if all zones have the same kind of sensors.

Select the targeted zone number with the keys „▲ “ and „▼ “.

„All“ : copy to all other zones.

The parameters will be copied after the „E “- key has been pressed.

While the copyfunction is activ: „COPY“ is shown.

End of this parameter level.

Next Display: „Zone on/off “

8. Parameter Level: Control Parameters

Adjustable for each controller zone individually.

This zone dependent parameters have to be set after programming the zone configuration.

Select individual zone with key „zone“.

Select the first parameter of this zone (setpoint 1 or setpoint 2) by pressing the key „P“. Adjust this parameter, if needed, with keys „▲“ and „▼“ and confirm it with the „E“-key.

Press key „P“ to select the next parameter.

If there is not keyboard-operation within appr. 30 seconds, the display will return to „zone information“ (actual value- and setpoint- display) of the selected zone.

If you want to leave this level: press key „E“ appr. 3 seconds.

Setpoint 1	Adjustment range: Lower setpoint limitation ... Upper setpoint limitation	(ex works: 0°C)
	Setpoint 1 will only be displayed here, if the instrument is in MANUAL – mode (manual output ratio).	
Setpoint 2	off; Lower setpoint limitation ... Upper setpoint limitation	(ex works: off)
	Setpoint 2 is valid for all zones, if the external contact K1 is closed. Setpoint2 = Off: Setpoint1 is still valid, if contact K1 is closed.	
Rising ramp	off; 0,1 ...99,9 °C/min. or °F/min. 0,01...9,99 °C/min. or °F/min. if range with dec.point is selected	(ex works: off)
Falling ramp	off; 0,1 ...99,9 °C/min. or °F/min. 0,01...9,99 °C/min. or °F/min. if range with dec.point is selected	(ex works: off)

A programmed ramp is always activated when the setpoint is altered or when the mains supply is switched on. The ramp constructs itself out of the momentary process value and the pre-selected setpoint. The ramp can be activated for both setpoint1 and setpoint2. By programming the second setpoint accordingly a setpoint profile can be obtained (please see example below).

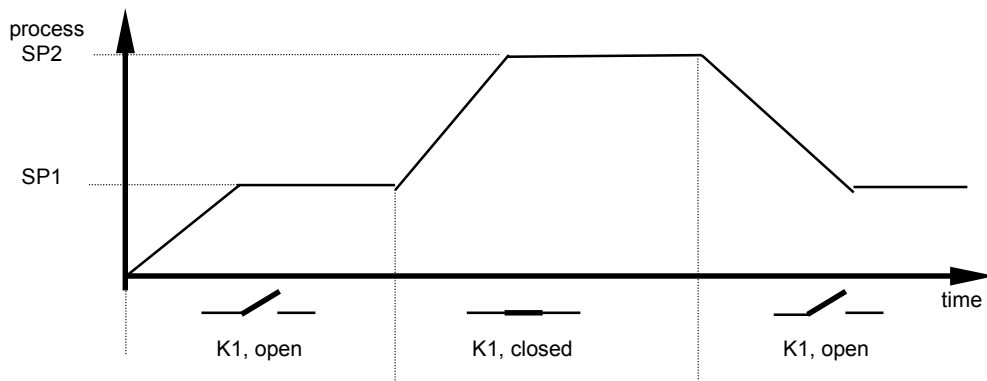

Alarm A1: Alarm value (switches relay A1)	Temperature monitoring:	alarm value adjustment / switching point	
	if „Signal contact“ is selected:	off= -200; -199... 199 °C/°F	(ex works: off)
	if „Limit comparator“ is selected:	off= 0; 1...199 °C/°F	(ex works: off)
	if „Limit contact“ is selected:	off= Measuring range, bottom end -1 Adjustment: Measuring range, bottom end ... top end	(ex works: off)
	Heater current monitoring:	alarm value adjustment / switching point	
	Limit contact	off=0; 0,1 ...99,9 A	(ex works: off)
Alarm A2: Alarm value (switches relay A2)	Temperature monitoring:	alarm value adjustment / switching point	
	if „Signal contact“ is selected:	off= -200; -199... 199 °C/°F	(ex works: off)
	if „Limit comparator“ is selected:	off= 0; 1...199 °C/°F	(ex works: off)
	if „Limit contact“ is selected:	off= Measuring range, bottom end -1 Adjustment: Measuring range, bottom end ... top end	(ex works: off)
	Heater current monitoring:	alarm value adjustment / switching point	
	Limit contact	off=0; 0,1 ...99,9 A	(ex works: off)

Max. output ratio limitation (%)	<p>0...100 % (ex works: 100)</p> <p>The limitation of the output ratio is only necessary, if the heating or cooling energy supply is grossly overdimensioned compared to the power required.</p> <p>Under normal circumstances no limitation is needed (setting = 100%). The limitation becomes effective, when the controllers' calculated output ratio is greater than the maximum permissible (limited) ratio.</p> <p>Warning! The output ratio limitation does not work during autotune.</p>
P Proportional band (%)	<p>off; 0,1...100,0 % (ex works: 3,0)</p> <p>If „off“, go to parameter „Switch sensitivity“.</p>
D Rate time (sec.)	<p>off; 1...200 secs. (ex works: 30)</p>
I Reset time (sec.)	<p>off; 1...1000 secs. (ex works: 150)</p> <p>Normally the controller works using PD/I control action. This means, controlling without deviation and with practically no overshoot during start-up.</p> <p>The control action can be altered in its structure by making the following adjustments to the parameters:</p> <ul style="list-style-type: none"> a. no control action, on-off (setting P = off) b. P-action (setting D and I = off) c. PD-action (setting I = off) d. PI-action (setting D = off) e. PD/I modified PID-action (set: P, D, I)
Cycle time (sec.)	<p>0,5...240,0 secs. (ex works: 10,0)</p> <p>The switching frequency of the actuator can be determined by adjusting the cycle time. This is the total time needed for the controller to switch on and off once.</p> <ul style="list-style-type: none"> a) Relay outputs: cycle time > 10 secs b) Bistable voltage outputs: cycle time 0,5...10 secs / optim. = 0,8secs.
Switch sensitivity	<p>Only if „P- Band“ = off (on-off action, without feedback)</p> <p>off; 0,1... 80,0 °C / °F (ex works: 0,1)</p> <p>off; 0,01... 8,00 °C / °F (only ranges with dec. point)</p>

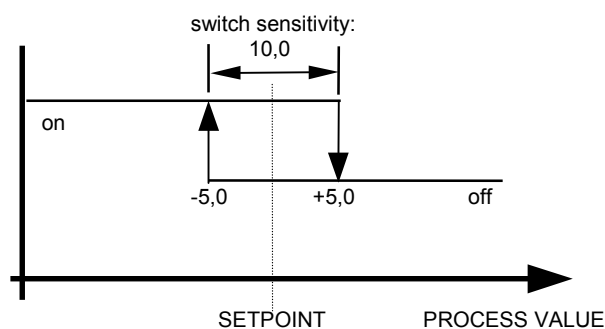

Autotune (selftuning algorithm)	off	autotune / self tuning out of action	(ex works: off)
	on	autotune / self tuning active (one time)	

The tuning algorithm determines the characteristic values within the controlled process, and calculates the valid feedback parameters (P,D,I) and the cycle time (= 0.3 x D) of a PD/I-controller for a wide section of the range.

The autotune activates during start-up shortly before the setpoint is reached.

The setpoint must amount to the least 5% of the total range.

If activated after the setpoint has already been reached, the temperature will first drop by approx. 5% of the total range, in order to detect the exact amplification of the process.

Autotune activ: indication in display „zone information“: OPT

The tuning algorithm can be activated at any time by selecting the **Autotune=on**.

After having calculated the feedback parameters, the controller will lead the process value to the actual setpoint.

Take care: If the softstart-function is activ, the autotune can't be activated.

Selecting **Autotune=off** will stop the autotune-function.

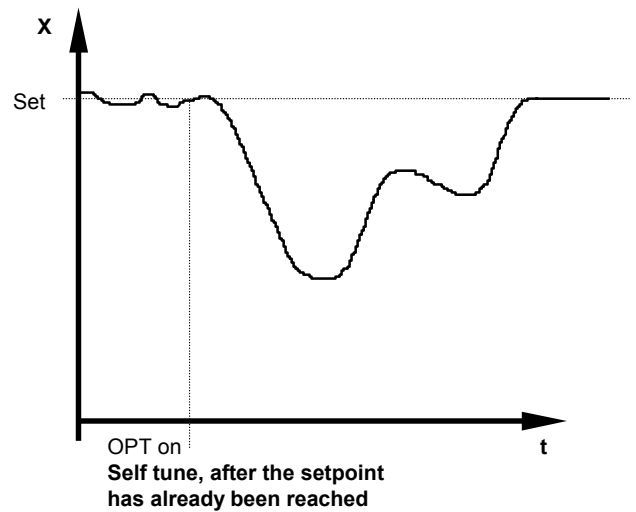
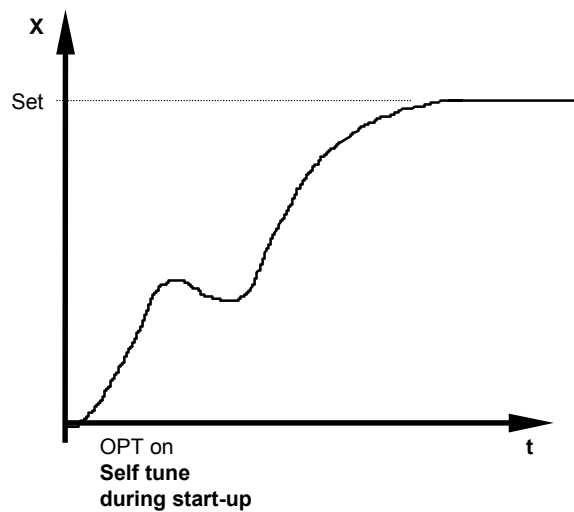

End of this parameter level.

Next Display: „Setpoint 1 or Setpoint 2“

9.3 Profibus- DP, general

The controller series **R2400** can be equipped with a Profibus-DP-interface acc. EN 50170.

Note: Only in PROFIBUS-technologie trained personnel following the safety regulations may do the PROFIBUS - connections.
It is essential, that one has well experience in installing a Profibus-device.

This allows to set and to read the process- and configuration-datas by a higher level computer (here called: master). The communication is always controlled by the master. The controller operates as a slave with its own address and different zones.

Interface: RS485
Twisted pair 2-wire connection. See EN 50170, Chapt. 2

Network-Topology: Linear bussystem with activ bus termination on both ends.
Spot lines are possible (depending of the used cable type):
3-12Mbit/sec. = max. lenght: 1,5m
1,5Mbit/sec. = max. lenght: 6,5m

Baud rate and wiring lenght (without repeater):

The baud rate will be detected by the Profibus-master automatically.
The maximal wiring lenght depends of the used baud rate.

Baud rate	Max. wiring lenght
93,745 kbit/sec.	1200m
187,5 kbit/sec.	1000m
500 kbit/sec.	400m
1,5 Mbit/sec.	200m
3 – 12 Mbit/sec.	100m

Connections:

The terminals (signals) VP and GND only are to be used to connect the external terminating resistors. There are no further connections allowed.

Plug-in terminals:

90	GND
91	VP +5V
92	CNTR
93	RxTxP
94	RxTxN

Device Adress:

Each device has it`s own adress (1...125), wich will be programmed via parameter „Device adress“. There are up to 32 device addresses in one segment programable.
With the help of a repeater up to 127 devices can be connected.
The single controller zones are called up within the protocol.

Special:

- Configuration channel für reading and writing of all available parameters.
- Configurable process data moduls.
- Diagnostic warnings, to detect sensor- and/or system errors.
- Easy connection to IPC`s or PLC`s.

Informations about the Profibus-communication: Select Parameter „Profibus DP: Baudrate“.

Bus-Status: **No Connection:** Profibus not connected or master not activ.
Wait Param: Master detected – Device expects parameter
Data Exchange: Data Exchange Modus
Error xxxx: Profibus-system error

Important:

Parameter „remote“ has to be set to „on“. Otherwise it is not possible to write datas into the device.

See:

Elotech-Discription and Data transfer Profibus-DP
FAQ`s: www.elotech.de → Products → Technical Data

10. Technical Data

Input PT100 (RTD):	2 - or 3 - wire connection possible. Built-in protection against sensor breakage and short circuit. Max. permissible line resistance by 3-wire connection: 80 Ohms Sensor current: ≤ 1 mA Calibration accuracy: $\leq 0,2$ % Linear error: $\leq 0,2$ % Influence of the ambient temperature: $\leq 0,01$ % / K
Input Thermocouple:	Built-in internal compensation point and protection against sensor breakage and incorrect polarity. Re-calibration not required for a line resistance of up to 50 Ohms. Calibration accuracy: $\leq 0,25$ % Linear error: $\leq 0,2$ % Influence of the ambient temperature: $\leq 0,01$ % / K
Setpoint selection:	Ext. potential-free contact, switching voltage appr. 24 V DC, max. 1 mA. Selection between Setpoint1 and Setpoint2 valid for all zones.
Analog input d1 (Option):	0 ... 10 V DC (Display range programmable)
Control outputs OUT 1 ... 8:	Bist. voltage signal, 0/18 V DC, max. 10 mA, short-circuit proof or Relay, max. 250 VAC, max. 3 A (cos-phi = 1)
Alarm outputs A1 and A2:	Relay, max. 250 VAC, max. 3 A (cos-phi = 1)
LCD-Display:	Blue STN-display with permanent, white LED-background lightening 128 x 64 pixel 8 lines with 21 characters each
Ser. interface (option):	RS232 or RS485 or 0/20mA (Protocol: ELOTECH-standard ASCII) CANopen, CiA Device Profile DS-404 Profibus DP, acc. EN 50170
Data protection:	EAROM
CE – mark:	Tested according to 89 / 336 / EWG EN 50081-2, EN 50082-2 Electr. safety: EN 61010
Power supply:	Standard: - 230 V AC (115VAC, 24VAC); ± 10 %, 48...62 Hz, appr. 10VA - 24 V DC, ± 25 %
Connections:	Screw terminals, Protection mode IP 20 (DIN 40050), Insulation class C
Permissible operating conditions:	Operating temperature: 0...50 °C / 32...122 °F Storage temperature: -30...70 °C / -22...158 °F Climate class: KWF DIN 40040; equivalent to annual average max. 75 % rel. humidity, no condensation
Casing:	Format, case: ¼-DIN; 96 x 96 mm (DIN 43700), installation depth 122 mm Panel cutout: 92 +0,5 mm x 92 +0,5 mm Format, face plate: 98 x 98 mm Material: Noryl, self-extinguishing, non-drip, UL 94-V1 Protection mode: IP 20 (DIN 40050), IP 50 front side
Weight:	app. 800 g

Subject to technical improvements!

11. Error displays

Display	Cause	Possible remedy
LOC	Parameter has been locked	Unlock, if need be. See: Device Configuration -> Adjustment lock
LOC EXT	Parameter has been locked by contact K2	Open contact K2
Er.H	Top range end has been exceeded, sensor defect	Check sensor and cable
Er.L	Bottom range end has been exceeded, sensor defect	Check sensor and cable
E.OP	Self tuning error	Extinguish error signal by pressing the „E“ - key. Check the self tuning conditions and restart.
E.SY	System error	Extinguish error signal by pressing the „E“ - key. Check all parameters. If the error signal continues please send the controller for examination.
E.O	System error	Please send the controller for examination.
REMO	Manual adjusting or programming of parameters not possible. Remote-status. Maybe controlled by the serial interface.	Set parameter „remote“ : off (Profibus DP)
KONF	Alarm configuration: off No alarm value adjustable.	Set „Alarm configuration“ See: Device Configuration -> Alarm Configuration.
E.SP2	Setpoint 2 active	Setpoint 2 can not be adjusted in display „zone information“. Adjustment only in level „Control parameter“ possible.

12. Installation Instructions

Make certain that the devices described here are used only for the intended purpose. They are intended for installation in control panels. The controller must be installed so that it is protected against impermissible humidity and severe contamination. In addition, make sure that the permitted ambient temperature is not exceeded.

The electrical connections must be made according to the relevant locally applicable regulations and by properly qualified personnel.

If using a thermocouple sensor, the compensation cables must be laid directly to the controller terminals.

Transducers must be connected only in compliance with the programmed range. Transducer cables and signal lines (e.g. logic or linear voltage outputs) must be laid physically separated from control lines and mains voltage supply cables (power cables).

Spatial separation between controller and inductive loads is recommended.

Interference from contactor coils must be suppressed by connecting adapted RC-combinations parallel to the coils.

Control circuits (e.g. for contactors) should not be connected to the mains power supply terminals of the controller.

Disclaimer of liability

We have checked the contents of the document for conformity with the hardware and software described. Nevertheless, we are unable to preclude the possibility of deviations so that we are unable to assume warranty for full compliance. The information given in the publication is, however, reviewed regularly. Necessary amendments are incorporated in the following editions.

We would be pleased to receive any improvement proposals which you may have.

The information contained herein is subject to change without notice.

ELOTECH Industrieelektronik GmbH

Verbindungsstr. 27

D - 40723 HILDEN, Germany

Tel.: 0049 2103 23055 Fax: 0049 2103 23057

www.elotech.de

E-mail: elotech@t-online.de