



# ELOTECH

## R1000-21 / R1040-21 / R1080-21

With service interface

**1 – Zone Temperature Controller: Heat-only  
Heating-off-cooling  
Three-point stepping**



Installation depth: 70mm

DIN-Format: 96mm x 96mm / 48mm x 96mm / 96mm x 48mm

### Description and operating manual





ELOTECH Industrieelektronik GmbH  
Verbindungsstraße 27  
D - 40723 HILDEN  
FON +49 2103 / 255 97 0      FAX +49 2103 / 255 97 29  
www.elotech.de              Email: info@elotech.de

# 1 Contents

1	Contents.....	2
2	General Information .....	3
3	Installation Instructions .....	3
4	Type Code.....	4
5	Connection Diagram .....	4
6	Service Interface.....	5
7	Display and Keyboard .....	6
7.1	Operating Levels .....	7
8	Parameter descriptions .....	8
8.1	Device configuration level .....	8
8.2	Alarm configuration level .....	13
8.3	Parameter level.....	15
8.4	Operating Level.....	19
9	Program Controller.....	20
9.1	Course of program control: .....	20
10	Error And Status Messages .....	22
11	Technical Data.....	23
12	Notes.....	24

## 2 General Information

Used symbols:

	Messages shown by the controller display
	Symbolizes the value of the factory adjustment of the respective parameter.
	This parameter is available in PID controller mode only.
	This parameter is available in Three-Point Stepping mode only.

## 3 Installation Instructions

Make sure that the device is used for the intended purpose only.  
This controller is designed for installation in control panels.  
Protect the device against impermissible humidity and contamination.

Ambient temperature must not exceed 50 °C (122 °F).  
Electrical connections must be made according to valid regulations and by properly qualified personnel.

If using thermocouple sensors, compensation lines have to be connected directly to the controller terminals. Sensors may be connected only in compliance with the programmed range.

Sensor cables and signal lines (e.g. logic or linear voltage outputs) must be laid separately from control lines and mains voltage supply cables (power cables).

**It is not permitted to connect the grounds of the sensor-inputs and logic-outputs with each other!**

Separate installation of controller and inductive loads is recommended.  
Interference from contactor coils must be suppressed by connecting adapted RC-combinations parallel to the coils.  
Control circuits (e.g. for contactors) should not be connected to the mains power supply terminals of the controller.

The configuration parameters are generally to be selected first.

### Disclaimer of Liability

We have checked the contents of this document for conformity with the hardware and software described. Nevertheless, we are unable to preclude the possibility of deviations so that we are unable to assume warranty for full compliance. However, the information given in the publication is reviewed regularly. Necessary amendments are incorporated in the following editions.  
We would be pleased to receive any improvement suggestions which you may have.  
The information contained herein is subject to change without notice.

Electronic scrap and components are subject to special treatment and must be disposed of by authorized companies.

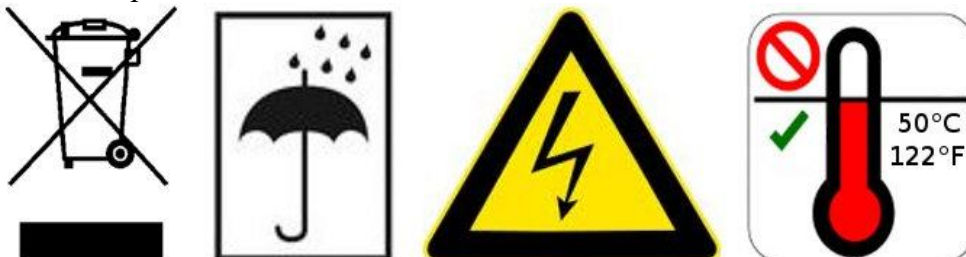

## 4 Type Code

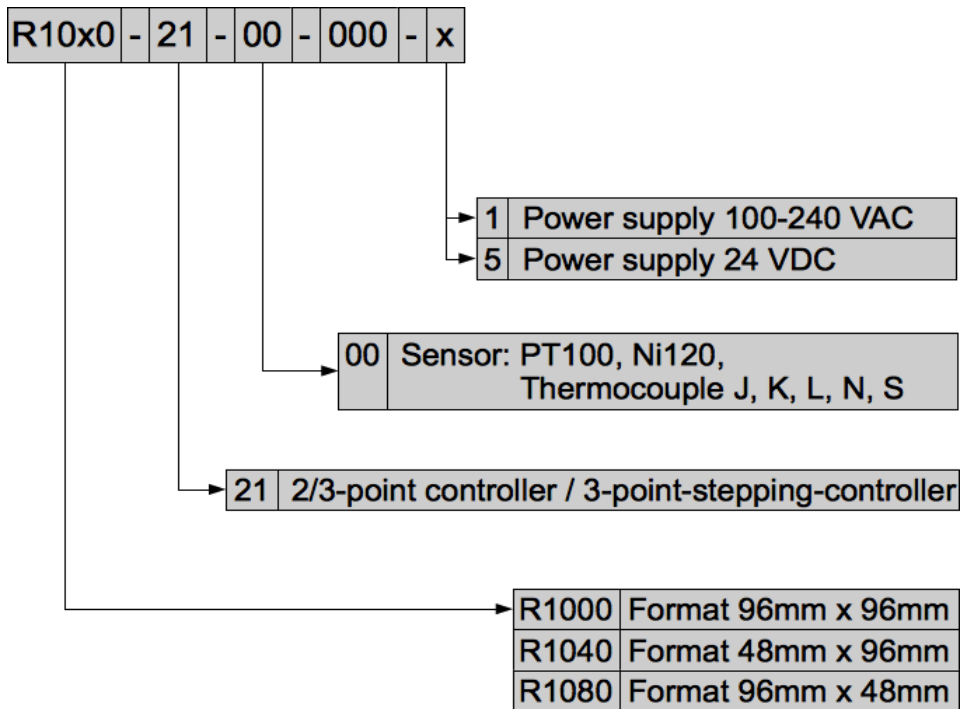

## 5 Connection Diagram

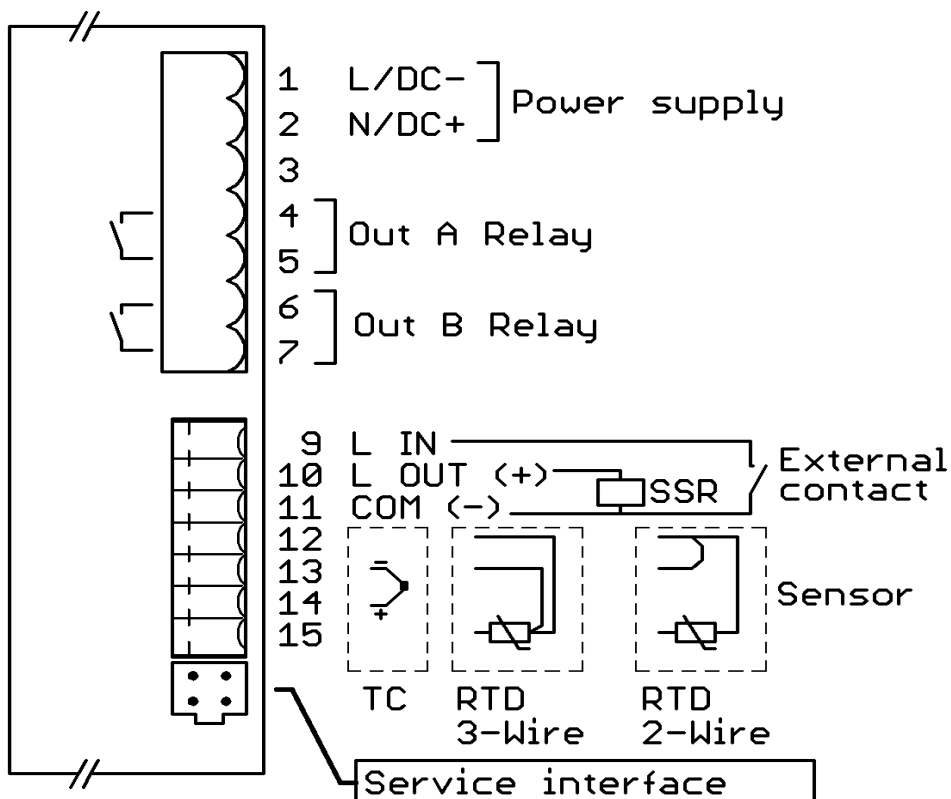

Note: For 2-wire operation of the Pt-100 sensor, a bridging connection is required between terminals 12 and 13.

## 6 Service Interface

The controller is equipped with a service interface. With the aid of the Elovision 3 program, the controller can be conveniently configured from the PC. The complete parameter set of the controller can be stored on the PC and transferred back to any controller if required.

So, the controllers easily can be provided with a prepared basic configuration during series production.

Required Adapter: RS232 Interface adapter for R10x0-21 (Item No: M-RS232-000)

Requirements of the PC:

- RS232 interface (or an USB to RS232 converter)
- Software "Elovision 3": Download free of charge at [www.elotech.de](http://www.elotech.de) in the download area.

**ATTENTION!** It is a pure configuration interface and commissioning tool.

It is not permitted as a fieldbus interface for monitoring or remote control of the controller.

The interface is not galvanically isolated!

## 7 Display and Keyboard

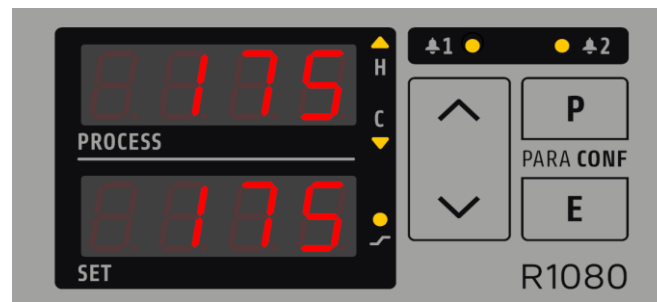

<b>LED H:</b>	Heating active	<b>LED</b>	Flashes: Setpoint ramp active	<b>LED A1:</b>	Alarm 1
<b>LED C:</b>	Cooling active			<b>LED A2:</b>	Alarm 2
			Program controller: Off: no program active Flashes: program runs On: Program is on hold		

If setpoint 2 or the external setpoint is selected, a decimal point is displayed behind the numerical value of the setpoint display.

### Key functions:

	Parameter key (parameter preselection)
	Adjustment of chosen parameter (e.g. setpoint) to higher or lower values. Short operation: single-step adjustment Longer operation: quick-scanning When the parameter adjustments have been altered but not entered, the display will flash bright/dark. In program controller mode these keys are used for the program functions instead of setpoint selection.
	Confirmation and storage of the preselected values. The display will show a light chain as a control of this function.

## 7.1 Operating Levels

The operation of the controller is divided into 4 levels.

After power up the device will be in the operating level.

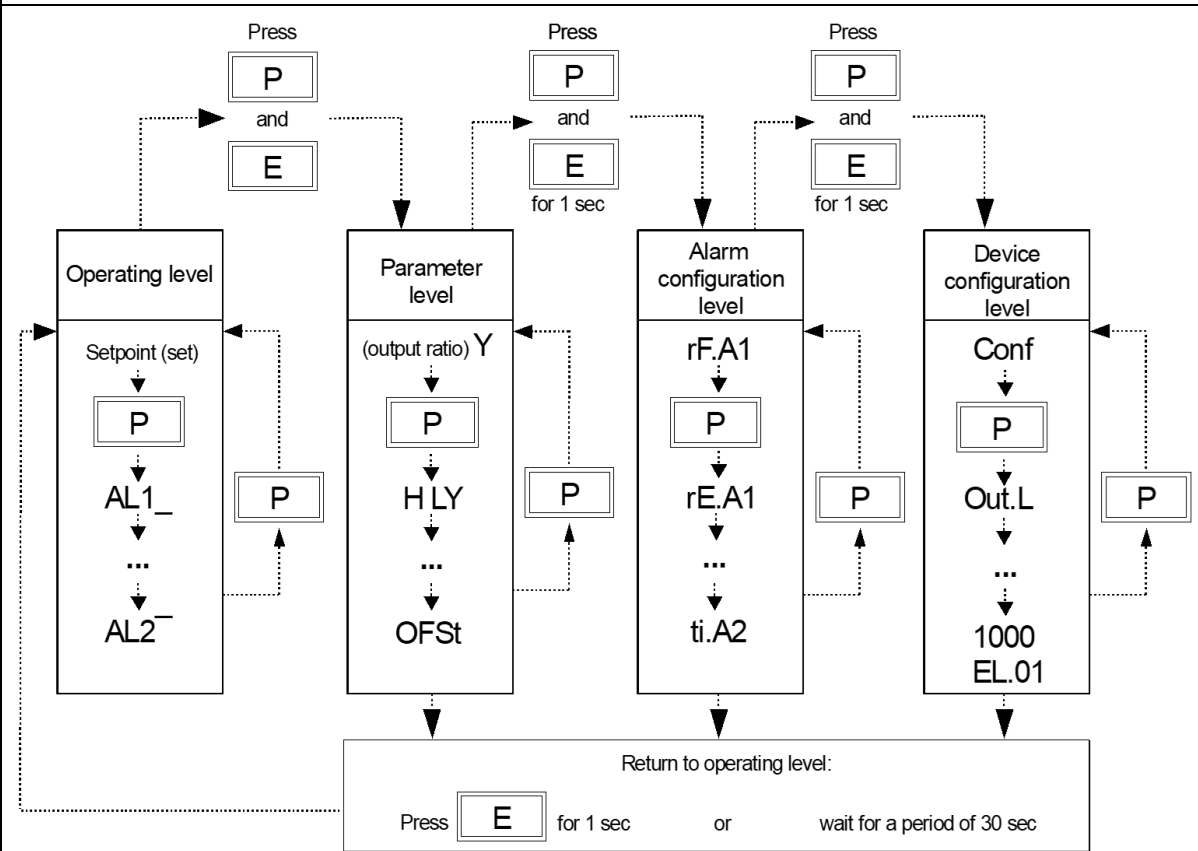

### Operating level:

Process- and Setpoint value will be displayed simultaneously.

In the operating level the setpoint and other parameters can be adjusted by pressing the "UP"- / "DOWN"-keys.

Every adjustment has to be confirmed by pressing the "E"-key.

All parameters in the operating level can, in succession, be displayed by pressing the "P"-key.

The three other levels can be reached by simultaneously pressing the "P"- and "E"-keys.

By pressing for a longer time (approx. 1 s) it can be switched to the next level.

The parameters are selected and set according to the descriptions of the operating level.

After either pressing the "E"-key for approx. 1 second, or waiting for a period of approx. 30 seconds, the unit will automatically return to the operating level.

### Control parameter level:

In the control parameter level the parameter values are adjusted to suit each individual process.

### Alarm configuration level:

In the alarm configuration level the parameters are adjusted for the alarm monitoring.

### Device configuration level:

In the configuration level the basic configurations of the controller are set.

These adjustments have to be carried out first of all when starting the controller for the first time.

## 8 Parameter descriptions

### 8.1 Device configuration level

<p><b>Conf</b> Controller <b>configuration</b></p>	When changing the controller configuration, the settings of the outputs will be changed, too. They can be altered manually afterwards.	
	<p><b>2P h</b></p>	2-point controller "heating-off" <§> Output settings: <b>OutL = H; OutA = AL1; OutB = AL2</b>
	<p><b>2P c</b></p>	2-point controller "cooling-off" Output settings: <b>OutL = C; OutA = AL1; OutB = AL2</b>
	<p><b>2Pnc</b></p>	2-point controller "cooling non-linear". Cooling action with non-linear cooling response curve (e.g. for vapour cooling) Output settings: <b>OutL = C; OutA = AL1; OutB = AL2</b>
	<p><b>3P</b></p>	3-point-controller "heating-off-cooling" Output settings: <b>OutL = H; OutA = C; OutB = AL1</b>
	<p><b>3Pnc</b></p>	3-point-controller "heating-off-cooling". Cooling action with non-linear cooling response curve (e.g. for vapour cooling) Output settings: <b>OutL = H; OutA = C; OutB = AL1</b>
	<p><b>3PSt</b></p>	Three-point-stepping controller Heating corresponds to "OPEN", Cooling corresponds to "CLOSE" Output settings: <b>OutL = AL1; OutA = H; OutB = C</b>
<p><b>OutL</b> Assignment of the signal for the output "Logic"</p>	<p><b>OFF</b></p>	Output is turned off
	<p><b>H</b></p>	Output represents the "heating"-signal<§>
	<p><b>C</b></p>	Output represents the "cooling"-signal
	<p><b>AL1</b></p>	Output represents the alarm 1-signal
	<p><b>AL2</b></p>	Output represents the alarm 2-signal
<p><b>OutA</b> Assignment of the signal for the output "Relay A"</p>	<p><b>OFF</b></p>	Output is turned off
	<p><b>H</b></p>	Output represents the "heating"-signal<§>
	<p><b>C</b></p>	Output represents the "cooling"-signal
	<p><b>AL1</b></p>	Output represents the alarm 1-signal
	<p><b>AL2</b></p>	Output represents the alarm 2-signal
<p><b>OutB</b> Assignment of the signal for the output "Relay B"</p>	<p><b>OFF</b></p>	Output is turned off
	<p><b>H</b></p>	Output represents the "heating"-signal<§>
	<p><b>C</b></p>	Output represents the "cooling"-signal
	<p><b>AL1</b></p>	Output represents the alarm 1-signal
	<p><b>AL2</b></p>	Output represents the alarm 2-signal

<b>SEn</b> Sensor selection	<b>P10C</b>	Pt100 -99,9...120,0 °C
	<b>P10F</b>	Pt100 -147...248 °F
	<b>P40C</b>	Pt100 0...400 °C <§>
	<b>P40F</b>	Pt100 32...752 °F
	<b>P80C</b>	Pt100 0...800 °C
	<b>P80F</b>	Pt100 32...1472 °F
	<b>n20C</b>	Ni120 0...250 °C
	<b>n20F</b>	Ni120 32...482 °F
	<b>L40C</b>	Thermocouple (TC) Fe-CuNi(L) 0...400 °C
	<b>L40F</b>	Thermocouple (TC) Fe-CuNi(L) 32..752 °F
	<b>L80C</b>	Thermocouple (TC) Fe-CuNi(L) 0...800 °C
	<b>L80F</b>	Thermocouple (TC) Fe-CuNi(L) 32..1472 °F
	<b>J80C</b>	Thermocouple (TC) Fe-CuNi(J) 0...800 °C
	<b>J80F</b>	Thermocouple (TC) Fe-CuNi(J) 32..1472 °F
	<b>K10C</b>	Thermocouple (TC) NiCr-Ni(K) 0..1200 °C
	<b>K10F</b>	Thermocouple (TC) NiCr-Ni(K) 32..2192 °F
	<b>S10C</b>	Thermocouple (TC) PtRh-Pt(S) 0..1600 °C
	<b>S10F</b>	Thermocouple (TC) PtRh-Pt(S) 32..2912 °F
<b>N10C</b>	Thermocouple (TC) NiCrSi-NiSi(N) 0...1200 °C	
<b>N10F</b>	Thermocouple (TC) NiCrSi-NiSi(N) 32...2192 °F	
<b>SPLo</b> Lower setpoint limitation	Lowest adjustable setpoint value <§ = 0 °C> programming range: bottom <b>SPHi</b> range ...	
<b>SPHi</b> Higher setpoint limitation	Highest adjustable setpoint value <§ = 400 °C> programming range <b>SPLo</b> ... top range	

### Ramp function:

A programmed ramp is always activated when the setpoint is changed or when the mains supply is switched on. The ramp starts at the actual process value and ends at the preselected setpoint.

<b>SPr</b> Rising ramp	<b>OFF</b> <§>; 0,1 ... 100,0 °C/min or °F/min
<b>SPf</b> Falling ramp	<b>OFF</b> <§>; 0,1 ... 100,0 °C/min or °F/min

### Softstart Function in General:

If the softstart function is selected, it has to be made sure that the bistable voltage (logic) output is activated. Otherwise the relays will be damaged.

During the softstart the controllers heating output response is limited to a preselected ratio, in order to achieve a slow drying of high performance heat cartridges. This results in a slower, more regular heating period. Simultaneously the output clock frequency is quadrupled.

Once the process value reaches the softstart setpoint, it remains stable at this value for the preselected duration time. At the end of this period the process value rises to the valid setpoint.

If the softstart is active, the controller's autotune function cannot operate (**E-OP**). If a setpoint ramp has been programmed, the softstart has priority, and the ramp will become active after the softstart has been completed.

The parameters for the softstart function are only available if the parameter P (xp) is programmed to a value  $\geq 0,1\%$  (parameter level).

The softstart only works if the actual process value is lower than the softstart setpoint at the time the controller is turned on.

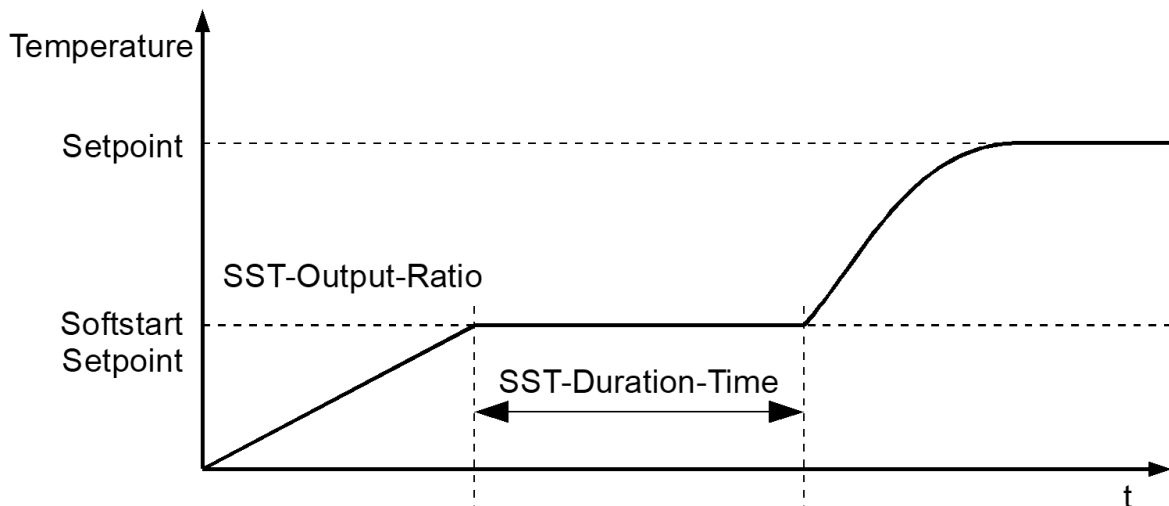

<b>S0St</b> Softstart >PID<	<b>OFF</b> Softstart function is not active. <§> The other softstart parameters are not displayed. <b>on</b> Softstart function is active.
<b>S0Y</b> Softstart output ratio Y >PID<	Range: 10...100% <§ = 30>
<b>S0SP</b> Softstart setpoint >PID<	Range: <b>SPLo</b> ... <b>SPHi</b> <§ = 100>
<b>S0t1</b> Softstart duration time >PID<	<b>OFF</b> Range: , 0.1 ... 10.0 min. <§ = 2.0>

<b>FEC2</b> (2nd parameter set)	<b>--</b>	No function selected <§>
	<b>SAVE</b>	Save actual parameter record to the 2nd parameter set
	<b>LOAD</b>	Load 2nd parameter record to actual parameter set
Use the 2nd parameter set to backup or restore the actual parameter set. Affected parameters: Control parameters, Setpoints and Setpoint configuration, Process offset, Ramps, Soft start and Alarm configuration The factory setting of the 2nd parameter set is identical to the actual parameter set.		
<b>MANd</b> Manual mode	<b>OFF</b>	Controller mode <§>
	<b>Auto</b> <b>Automatic Mode</b>	In the case of a sensor break the last valid output ratio is maintained.  An "H" is then displayed as the first digit in the setpoint display, followed by the valid output ratio. Like the setpoint, the output ratio can be changed manually.  Under the following circumstances, the output ratio will be 0%: - if the output ratio at the time of the sensor break was 100%. - if a setpoint ramp is active. - if the control deviation was more than 0,25% of the total range at the time of sensor break. - if the Proportional-band (P) = off. - if the softstart was active at the time of the sensor break.  A few seconds after the sensor break has been rectified, the controller returns to automatic operation and calculates the required output ratio.  An additional signal can be issued in the event of sensor break, if the alarm contacts are programmed accordingly.
	<b>MAN</b> <b>Manual Mode</b>	The controller now operates only as an actuator. The control function (PID) is inactive.  PROCESS: Actual process value is shown. Display of setpoint: First an "H", then the actual adjustable output ratio. Negative value: cooling, positive value: heating  Like the setpoint, the output ratio can be changed manually.
<b>Co5b</b> <b>Configuration Sensor break</b> Behaviour of the relays in case of sensor break  >DPS<	<b>OFF</b>	Outputs: OPEN = off CLOSE = off<§>
	<b>OPEN</b>	Outputs: OPEN = <b>on</b> CLOSE = off
	<b>CLOS</b>	Outputs: OPEN = off CLOSE = <b>on</b>
<b>FiLi</b> <b>Filter time</b>	<b>OFF</b>	Range: ; 0.1 ... 10.0 s <§ = OFF> If the process is not stable, filter time can be set to reduce oscillations of the process display. It has no influence on the controlling process.

<b>LOC1</b> Functions for the external contact	<b>Loc</b>	Contact closed: LOC parameter is not adjustable.
	<b>SP2</b>	Contact closed: Setpoint 2 is active
	<b>PrSt</b>	Close contact (edge-controlled): Start program controller Open contact (edge-controlled): Stop program controller
<b>LOC</b> Adjustment lock	<b>OFF</b>	no adjustment lock <§>
	<b>PC</b>	parameter and configuration levels locked
	<b>nSP1</b>	all parameters apart from SP1 locked ( <b>not SP1</b> )
	<b>ALL</b>	all parameters locked
<b>LUN1</b> Luminance		Adjustment of the luminance of the 7-segment-display. Adjustment range : 0...6<§>
<b>1000</b> / <b>1040</b> / <b>1080</b>		Device code and version
<b>50FE</b>		Firmware version
<b>50F0</b>		Firmware version of option board

## 8.2 Alarm configuration level

General alarm information (example alarm 1):

Description	Based to setpoint	Absolut
Alarm configuration	<code>FFA1=BASE</code>	<code>FFA1=ABS</code>
Range of alarm value	0...100 / -100...0	Whole measuring range
Switch point	Setpoint + alarm value	Alarm value
<p>Singlesided alarm "top": (over temperature alarm)</p> <p>The temperature has to be higher to activate the alarm.</p> <p>The under temperature alarm is not active: <code>AL1_ = OFF</code></p>		
<p>Singlesided alarm "bottom": (under temperature alarm)</p> <p>The temperature has to be lower to activate the alarm.</p> <p>The over temperature alarm is not active: <code>AL1_ = OFF</code></p>		
<p>Both-sided alarm: (limit-alarm)</p> <p>The temperature has to be outside the selected range.</p> <p>Both alarms (<code>AL1_</code> and <code>AL2_</code>) have to be set.</p>		

The parameter for the alarm values (`AL1_`, `AL1_`, `AL2_`, `AL2_`) are located in the operating level.

### Please note:

In case of sensor error the alarms react in the same way as range override.

The alarm contacts therefore do not offer protection against all types of plant breakdown.

We recommend the use of a second, independent monitoring unit.

<b>FFA1</b> Alarm 1 configuration (reference. alarm 1)	<b>ABS</b>	absolute <§ >
	<b>BASE</b>	based on setpoint
<b>FEA1</b> relay action for alarm 1	<b>OFF</b>	relay is turned <b>off</b> when alarm 1 is active
	<b>ON</b>	relay is turned <b>on</b> when alarm 1 is active <§ >
<b>LDA1</b> Display of front LED at alarm 1	<b>OFF</b>	LED is turned <b>off</b> when alarm 1 is active
	<b>ON</b>	LED is turned <b>on</b> when alarm 1 is active <§ >
<b>STA1</b> Start up suppression alarm 1	<b>OFF</b>	Start up suppression deactivated <§ >
	<b>Start</b>	Start up suppression activated The temperature has to enter the "OK range" once. Thereafter the alarm triggers when the temperature reaches the alarm limits.
<b>ETA1</b> delay time alarm 1	<b>OFF</b>	, 1 ... 1000 s <§ = OFF>

<b>FFA2</b> Alarm 2 configuration reference. alarm 2	<b>ABS</b>	absolute <§ >
	<b>BASE</b>	based on setpoint
<b>FEA2</b> relay action for alarm 2	<b>OFF</b>	relay is turned <b>off</b> when alarm 2 is active
	<b>ON</b>	relay is turned <b>on</b> when alarm 2 is active <§ >
<b>LDA2</b> Display of front LED at alarm 2	<b>OFF</b>	LED is turned <b>off</b> when alarm 2 is active
	<b>ON</b>	LED is turned <b>on</b> when alarm 2 is active <§ >
<b>STA2</b> Start up suppression alarm 2	<b>OFF</b>	Start up suppression deactivated <§ >
	<b>Start</b>	Start up suppression activated The temperature has to enter the "OK range" once. Thereafter the alarm triggers when the temperature reaches the alarm limits.
<b>ETA2</b> delay time alarm 2	<b>OFF</b>	, 1 ... 1000 s <§ = OFF>

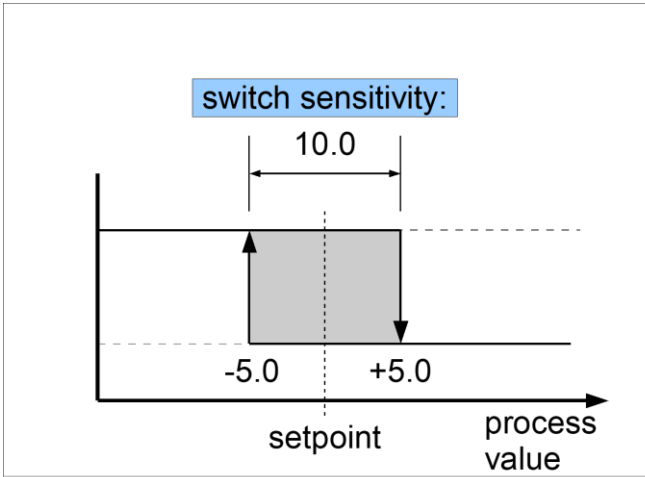

<b>P</b> xp, prop.-band (P) >DPS<	<b>OFF</b> ; 0.1 ... 200.0 % <§ = 10.0>
<b>t<sub>S</sub></b> Motor actuating time (d)>DPS<	5 ... 800 s <§ = 40>
<b>t<sub>n</sub></b> reset time (l) >DPS<	0.5 ... 80.0 min <§ = 3.0>
<b>H S<sub>d</sub></b> <b>S<sub>d</sub></b> switch sensitivity "heating"	This parameter is only available if: <b>H P= OFF</b> <b>OFF</b> ; 0.1<§> ... 80.0 

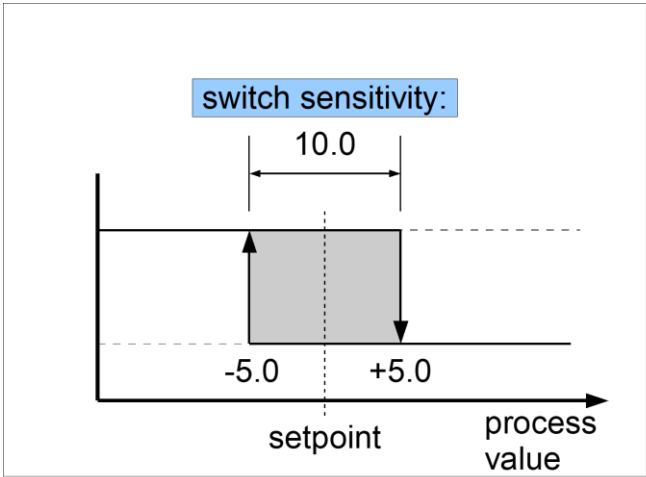

<p><b>5h</b> Switch point difference "heating" and "cooling"</p>	<p><b>OFF</b> ; 0.1&lt;<b>§</b>&gt; ... 20.0 If the controller is in heating mode, the actual process value has to rise by the adjusted value above the setpoint before the cooling mode will become active. By this the switching frequency between the heating and cooling outputs can be reduced. Simultaneous activation of heating and cooling outputs is not possible.</p>
<p><b>P</b> prop. band (P) "cooling"</p>	<p><b>OFF</b> ; 0.1 ... 100.0 % &lt;<b>§=3,0</b>&gt; If <b>P= OFF</b> (control action: on-off, without feedback) next parameter: <b>5d</b></p>
<p><b>d</b> rate (D) "cooling"</p>	<p><b>OFF</b> ; 1 ... 200 s &lt;<b>§ = 30</b>&gt;</p>
<p><b>I</b> reset(I) "cooling"</p>	<p><b>OFF</b> ; 1 ... 1000 s &lt;<b>§ = 150</b>&gt;</p>
<p><b>cy</b> cycle time "cooling"</p>	<p><b>OFF</b> 0.5 ... 240.0 s &lt;<b>§ = 15.0</b>&gt; The switching frequency of the actuator can be determined by adjusting the cycle time. In this time interval the controller switches on and off once.  Voltage outputs for SSRs cycle time: 0.5...10 s Optimal value for fast control loops: 0.8 s  Relay outputs: cycle time: &gt; 15 s The cycle time should be adjusted to a time as long as possible to minimize the wear of the relay contacts.</p>
<p><b>5d</b> switch sensitivity "cooling"</p>	<p>This parameter is only available if: <b>P= OFF</b> <b>OFF</b> ; 0.1&lt;<b>§</b>&gt; ... 80.0 °C</p> <div data-bbox="683 1326 1332 1803" data-label="Figure"> </div>

**Autotune:**

The tuning algorithm determines the characteristic values within the controlled process and calculates the valid feedback parameters (P, D, I) and the cycle time (= 0.3 x D) of a PD/I-controller for a wide section of the range.

The autotune mode is activated during start-up shortly before the setpoint is reached. If activated after the setpoint has already been reached, the temperature will first drop by approx. 5 % of the measuring range in order to detect the exact amplification of the process.

The tuning algorithm can be activated at any time by selecting **OPT = on** and pressing the "E"-key. After having calculated the correct feedback parameters, the controller will lead the process value to the setpoint.

**OPT OFF** = will stop the autotune function.

Zone display: During self **OPT** tuning is shown in the display, alternating with the setpoint value.

Conditions for starting the Autotune algorithm:

- The setpoint must add up to at least 5 % of the measuring range.
- The sensor must not have a failure.
- The softstart function must not be active.

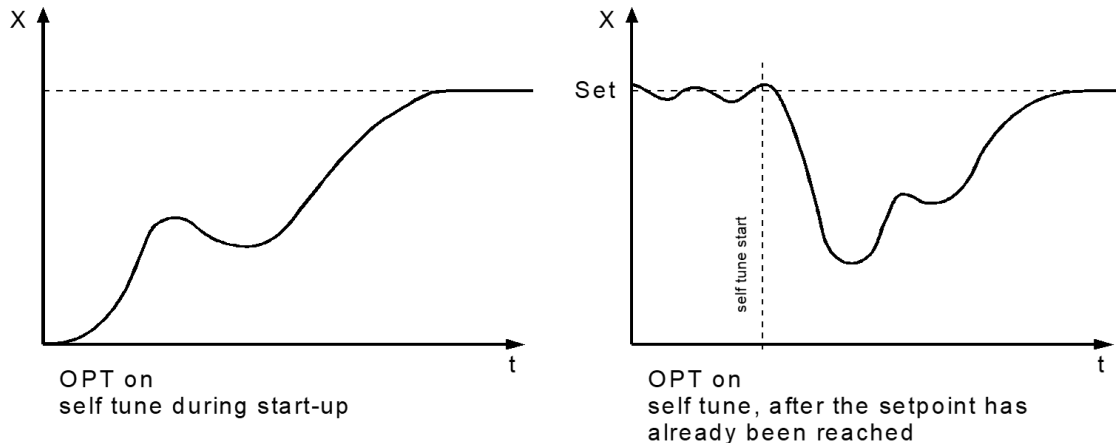

<b>OPT</b> autotune	<b>OFF</b> autotune / self tuning out of action <§>
	<b>on</b> autotune / self tuning active ( one time)
	<b>Auto</b> Autotune starts every time the controller is turned on, if the difference between setpoint and actual process value is more than 7 % of the measuring range.
<b>OFFSE</b> process value offset	- <b>OFF</b> 999... <§> ... 1000 °C/°F  This parameter serves to correct the input signal, e.g. for: - the correction of a gradient between the measuring point and the sensor tip - the line resistance balancing of 2-line RTD (Pt100) sensors - correction of the control deviation when using P- or PD-action  If for example the offset value is set to +5°C, the real temperature measured by the sensor (when process is balanced) is 5 °C less than the setpoint and the displayed actual process value. Make sure that the corrected temperature process value does not leave the selected measuring range.

## 8.4 Operating Level

The controller shows the process value and the setpoint if no one of the following parameters is selected.

<b>SP2</b> set point 2	<b>OFF</b> <b>SPLo</b> <b>SPHi</b> ...
<b>H 0</b> Manual output ratio	Adjustment of the manual output ratio: 0...100% The parameter is only visible if the controller is configured in parameter <b>Hand</b> to manual mode. Negative values are "cooling"
The function and configuration of the alarms is described in the chapter "alarm configuration level". Within the operating level only the alarm values can be set.	
	<b>Alarm reference</b> <b>Adjustment range:</b>
<b>AL1</b> Alarm 1: alarm value under temperature	<b>rFR1 = ABS</b> <b>OFF&lt;s&gt;</b> ; <b>SPLo</b> .. <b>SPHi</b> absolute Alarm active if the actual process value is lower than the alarm value
	<b>rFR1 = BASE</b> <b>OFF&lt;s&gt;</b> -1 ... -100 °K; based to setpoint Alarm active if the actual process value is lower than (Setpoint + alarm value)
<b>AL1</b> Alarm 1: alarm value over temperature	<b>rFR1 = ABS</b> <b>OFF&lt;s&gt;</b> ; <b>SPLo</b> .. <b>SPHi</b> absolute Alarm active if the actual process value is higher than the alarm value
	<b>rFR1 = BASE</b> <b>OFF&lt;s&gt;</b> ; 1 ... 100 °K based to setpoint Alarm active if the actual process value is higher than (Setpoint + alarm value)
<b>AL2</b> Alarm 2: alarm value under temperature	<b>rFR2 = ABS</b> <b>OFF&lt;s&gt;</b> ; <b>SPLo</b> .. <b>SPHi</b> absolute Alarm active if the actual process value is lower than the alarm value
	<b>rFR2 = BASE</b> <b>OFF&lt;s&gt;</b> -1 ... -100 °K based to setpoint Alarm active if the actual process value is lower than (Setpoint + alarm value)
<b>AL2</b> Alarm 2: alarm value over temperature	<b>rFR2 = ABS</b> <b>OFF&lt;s&gt;</b> ; <b>SPLo</b> .. <b>SPHi</b> absolute Alarm active if the actual process value is higher than the alarm value
	<b>rFR2 = BASE</b> <b>OFF&lt;s&gt;</b> ; 1 ... 100 °K based to setpoint Alarm active if the actual process value is higher than (Setpoint + alarm value)
<b>Prog</b> Program controller	<b>OFF</b> Program controller inactive. <b>&lt;s&gt;</b> <b>on</b> Program controller activated.

## 9 Program Controller

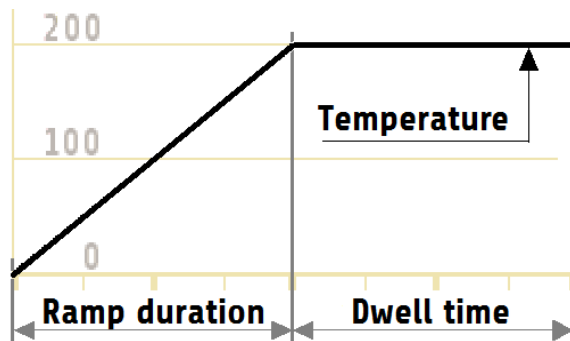

### 9.1 Course of program control:

1. Define the number of steps with the `ENTS` parameter .  
Every step consists of ramp time, ramp setpoint and dwell time.  
The times can be deactivated by setting the value to 0.
2. Define the behaviour at the end of the ramp phase. Normally the controller waits for the adjusted ramp time before the dwell time starts. Set `ENDS` to `LINE`.  
If the parameter `ENDS` is set to `TEMP`, the dwell time starts regardless of the ramp time when the actual value has reached the setpoint of the respective step.
3. Define the behaviour at the end of the program with parameter `ENDP`:  
Control operation with setpoint 1, control operation with the last ramp setpoint or restart of the program.
4. Select the values for ramp time, ramp setpoint and dwell time.
5. Working with the program controller:

Start the program with the key .

The display shows `Start` for a short time, the ramp-LED flashes.

Pressing  again sets the program on hold.

The display shows `hold` for a short time, the ramp-LED is on.

Resume the program by pressing  again.

The display shows `RESU` for a short time, the ramp-LED flashes.

Stop the program with the key .

The display shows `STOP` for a short time, the ramp-LED is off.

Afterwards, the program can be started for a new cycle.

The rate of the ramp is due to the ramp time, the last setpoint and the actual setpoint.  
When starting the program the first ramp will start from the actual process value.

The program also can be started by using the external contact.

For this the parameter `Loc 1` must be set to `Pr.St`.

The following parameters are visible if the parameter **Prog** is set to ON.

<b>EndS</b> Number of steps	1 ... 6 <b>&lt;§=1&gt;</b>	
<b>EndS</b> Behaviour at the end of a ramp phase	<b>EndE</b>	The dwell time will start directly after completing the ramp time. All steps will be processed in the adjusted times. <b>&lt;§&gt;</b>
	<b>EndP</b>	The dwell time starts as soon as the process value has reached the ramp setpoint (with a tolerance of +- 2K).  So the adjusted ramp time defines the rate of the setpoint, but has no influence on the beginning of the dwell time.
<b>EndP</b> Behaviour after the program has finished	<b>SP1</b>	Control operation with the actual setpoint <b>&lt;§&gt;</b> Normally: setpoint 1.
	<b>LastE</b>	Control operation with the setpoint of the last step
	<b>REPL</b>	Restart the program beginning with the first step.
<b>1rA</b> Step 1 Ramp time	0 ... 6000 min <b>&lt;§=0&gt;</b> In this time interval the setpoint runs linearly from the last step temperature to the setpoint of the actual step. The first step starts with the actual process value. *Switch off the ramp function by setting the value to 0 min.	
<b>1SP</b> Step 1 Ramp setpoint	<b>SPL0</b> ... <b>SPH1</b> <b>&lt;§=50°C&gt;</b> Setpoint for this step.	
<b>1E1</b> Step 1 Dwell time	0 ... 6000 min <b>&lt;§=0&gt;</b> The dwell time starts after the ramp has finished. The controller will work with the ramp setpoint for this time.	
...	Steps 2-6 are equal to step 1...	
<b>6rA</b> Step 6 Ramp time	0 ... 6000 min <b>&lt;§=0&gt;</b>	
<b>6SP</b> Step 6 Ramp setpoint	<b>SPL0</b> ... <b>SPH1</b> <b>&lt;§=50°C&gt;</b>	
<b>6E1</b> Step 6 Dwell time	0 ... 6000 min <b>&lt;§=0&gt;</b>	

## 10 Error And Status Messages

Error Message	Cause	Possible remedy
<b>SPLo</b>	Lower setpoint limit has been reached	Reduce limit, if need be
<b>SPHi</b>	Upper setpoint limit has been reached	Increase limit, if need be
<b>LOC</b>	Parameter has been locked	Unlock, if need be Device configuration <b>LOC</b> level:
<b>ErHi</b>	Top range end has been exceeded, sensor defect	Check sensor and cable
<b>ErLo</b>	Bottom range end has been exceeded, sensor defect	Check sensor and cable Check process value offset
<b>ErOP</b>	Self tuning error	Quit error message by pressing the key "E". Check the self tuning conditions and restart.
<b>ErSY</b>	System error	Quit error message by pressing the key "E". Check all parameters. If the error message continues, please send the controller back to the manufacturer.
<b>ErFD</b>	Parameter inconsistency detected in the factory calibration dataset responsible for regulating temperature indication precision	Send controller back to the manufacturer
<b>OFF</b>	When starting the program controller: No ramp or dwell time is set.	Check the parameters. Set times for <input type="text"/> and/or <input type="text"/> for the desired steps.
<b>Start</b>	Program controller started	Only info message
<b>hold</b>	Program controller set to hold	Only info message
<b>RESu</b>	Program controller resumed	Only info message
<b>STOP</b>	Program controller stopped	Only info message

# 11 Technical Data

Input PT100 (RTD)	2- or 3-wire connection possible Built-in protection against sensor break and short circuit Sensor current: < 0,5 mA Accuracy: ... ≤ 0,2 % Linear error: ... ≤ 0,2 % Influence of the ambient temperature: ... ≤ 0,01 % / K	
Input Thermocouple	Built-in internal compensation point and protection against sensor break and incorrect polarity. Re-calibration not required for a line resistance of up to 50 Ohm. Accuracy: ... ≤ 0,25 % Linear error: ... ≤ 0,2 % Influence of the ambient temperature: ... ≤ 0,01 % / K Influence of the resistance of the sensor cable on the measured voltage: ≤5uV at 10 Ohm. The resulting temperature error depends on the sensor type. (e.g. 20 Ohm → 10uV → Type J: 0,2C° Type S: 0,5°C)	
Output logic	Voltage signal, 0 / 9,5 V DC, max. 10 mA, short-circuit proof	
Outputs relay	Relay, max. 250 VAC, max. 2 A (resistive load) For control loops requiring a high switching frequency of the control output it is recommended to use the logic output controlling a SSR.	
7-Segment-Display:	4 digits, Process: 10 mm red, Set: 10 mm red	
Data protection	EAROM	
CE-mark	Tested according to: EN61326-2013 Class A / EN61000-3-2:2014 / EN61000-3-3:2013 Electrical safety: EN 61010-1	
Power supply	Depends on the version of the device: - 85 - 264 V AC, 48...62 Hz; approx. 3VA - 24 V DC, +/-25 %, approx. 3W	
Connections	Plug in terminals, Protection mode IP 20 (DIN 40050), Insulation class I Conductor cross section terminals 1-7: 0,2 – 2,5mm <sup>2</sup> (AWG: 30 - 12) Conductor cross section terminals 9-15: 0,14 – 1,5mm <sup>2</sup> (AWG 28 - 16)	
Permissible operating conditions	Operating temperature: Storage temperature: Climate class:	0 ... 50°C / 32 ... 122°F -30 ... 70°C / -22 ... 158°F KWF DIN 40040; equivalent to annual average max. 75 % rel. humidity, no condensation
Casing	Material: Protection mode: Case: Format R1000: Format R1040: Format R1080:	Noryl, self-extinguishing, non-drip, UL 94-V1 IP 20 (DIN 40050), IP 50 front side DIN 43700, installation depth approx. 60 mm 96 x 96 mm Panel cutout: 92 +0,5 mm x 92 +0,5 mm 48 x 96 mm Panel cutout: 45 +0,6 mm x 92 +0,8 mm 96 x 48 mm Panel cutout: 92 +0,8 mm x 45 +0,6 mm
Weight	Approx. 350 g depending on the version of the device	

Subject to technical improvements.

## 12 Notes