



ELOTECH

R 2100 - 62x : 6 - Zones „heat-only“ Temperature Controller

R 2100 - 82x : 8 - Zones „heat-only“ Temperature Controller

- Heater Current Monitoring (Option)
- CANopen Interface (Option)
- 2 x Analog Input 0-10VDC (Option)

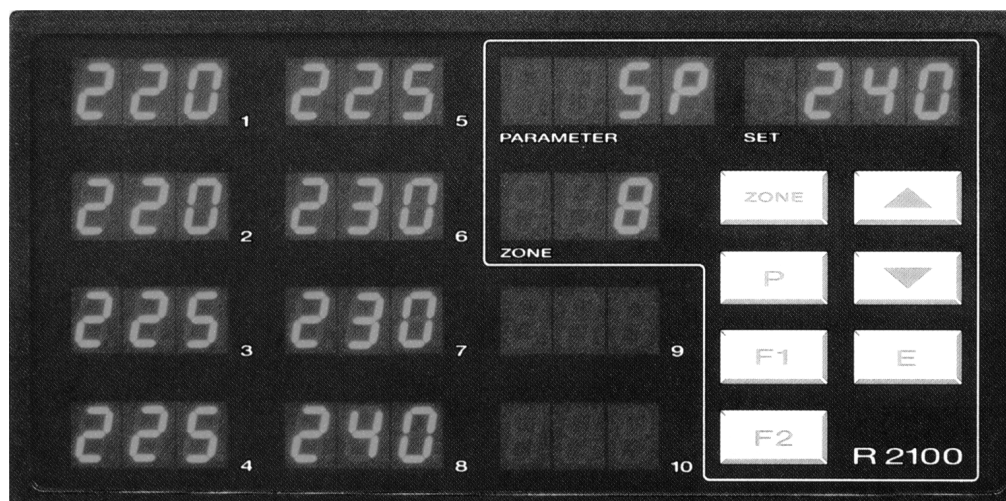

DIN-Format: 192 x 96 mm
Installation depth: 122 mm

DESCRIPTION AND OPERATING MANUAL

ELOTECH Industrieelektronik GmbH
Verbindungsstrasse 27
D – 40723 HILDEN
FON +49 2103 / 255 97 0 FAX +49 2103 / 255 97 29
www.elotech.de Email: info@elotech.de

Contents

Type code	Page	3	
Connection diagram, relais control outputs.	4		R2100 -621, -821
Connection diagram, bist. voltage control outputs. Com.: +	5		R2100 -622, -822
Connection diagram, bist. voltage control outputs. Com.: -	6		R2100 -626, -826 (preference)
Display and keyboard, general	7		
Display: process values, setpoints, tendency, heater current value	8		
Tendency display, controller outputs, alarm indication	9		
Operating levels, general	10		
Configuration level, general (zone 0)	11		General settings
Heater current monitoring	13		
Configuration level, zone dependend (zones 1...8)	16		Individual settings for each zone
Parameter level	19		
Operating level	21		
Technical data	22		
Error displays	23		
Installation instructions	23		

**Please read this operating manual carefully before starting up.
Observe the installation and connecting instructions.**

Type code

R 2100 - aaa - x - y - 000 - d - z

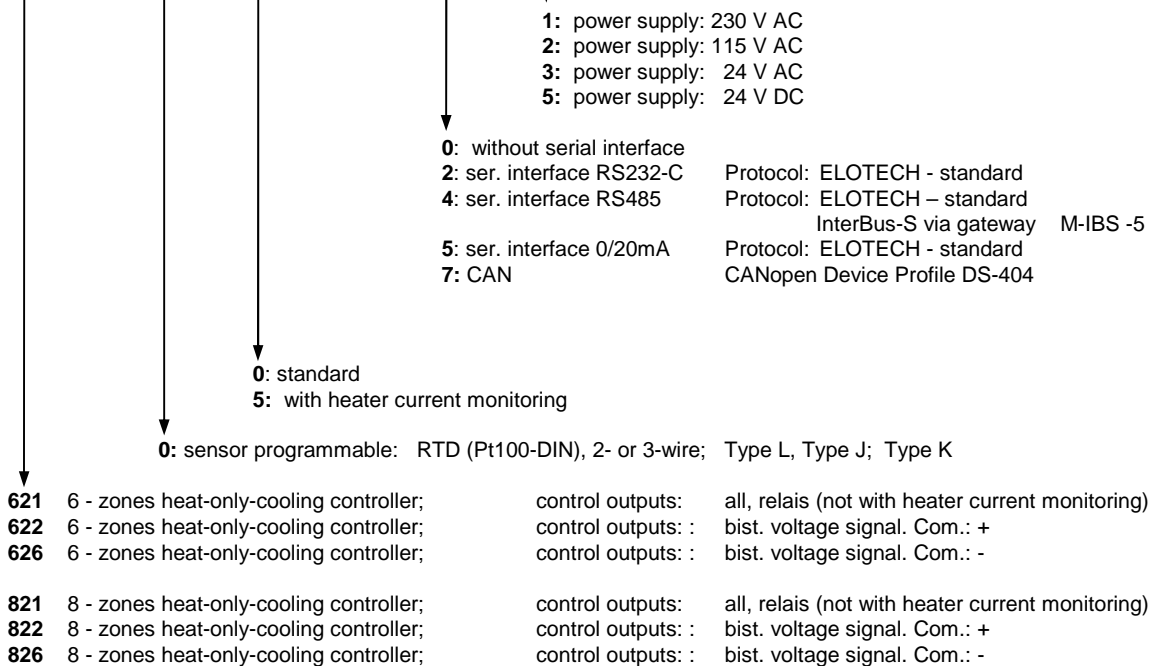

Connection Diagram: R 2100 - 621 R 2100 - 821

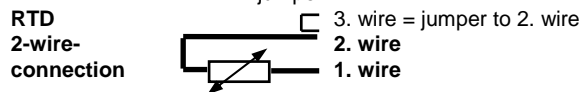
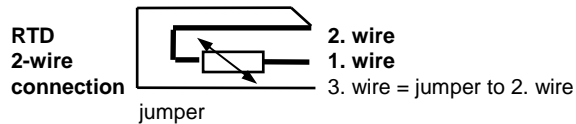
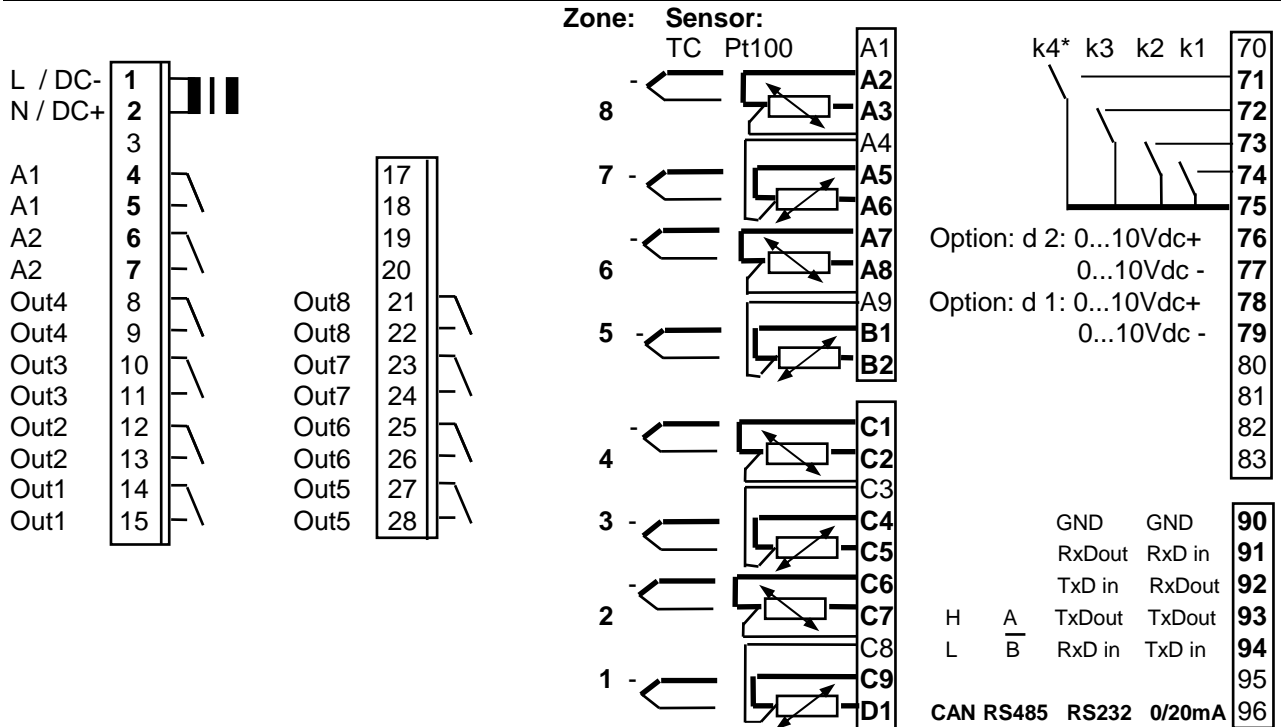

Control output OUT 1: Zone 1; control output „heating“ or „cooling“
Control output OUT 2: Zone 2; control output „heating“ or „cooling“
Control output OUT 3: Zone 3; control output „heating“ or „cooling“
Control output OUT 4: Zone 4; control output „heating“ or „cooling“
Control output OUT 5: Zone 5; control output „heating“ or „cooling“
Control output OUT 6: Zone 6; control output „heating“ or „cooling“
Control output OUT 7: Zone 7; control output „heating“ or „cooling“
Control output OUT 8: Zone 8; control output „heating“ or „cooling“

Alarm Output A1: Alarm 1 (Temperature monitoring alarm A1 for all zones)
Alarm Output A2: Alarm 2 (Temperature monitoring alarm A2 for all zones)

Input d1: 0 ... 10 Vdc, OPTION Zone: d1
Input d2: 0 ... 10 Vdc, OPTION Zone: d2

Setpoint Controlling: K1: open = Setpoint 1 (SP1) valid
 K1: closed = Setpoint 2 (SP2) valid, for all zones

Adjustment lock (LOC): K2: open = Adjustment lock only via „software code“ (see parameter: LOC)
 K2: closed. = Adjustment locked according to the choosen „software code“.

Setpoint changing: K3: open = individual setpoint adjustment for each zone
 K3: closed = if setpoint has been changed in one zone, this new setpoint is valid (will be overtaken) for all other zones automatically.

CAN-Interface: K4: open = CAN: „operational“. Operation only with CANopen protocoll.
 K4: closed = CAN: „operational“ always active.
 „k4“ must be closed, if the instrument is equipped with a CAN-interface but not used.

Connection Diagram: R 2100 - 622 R 2100 - 822

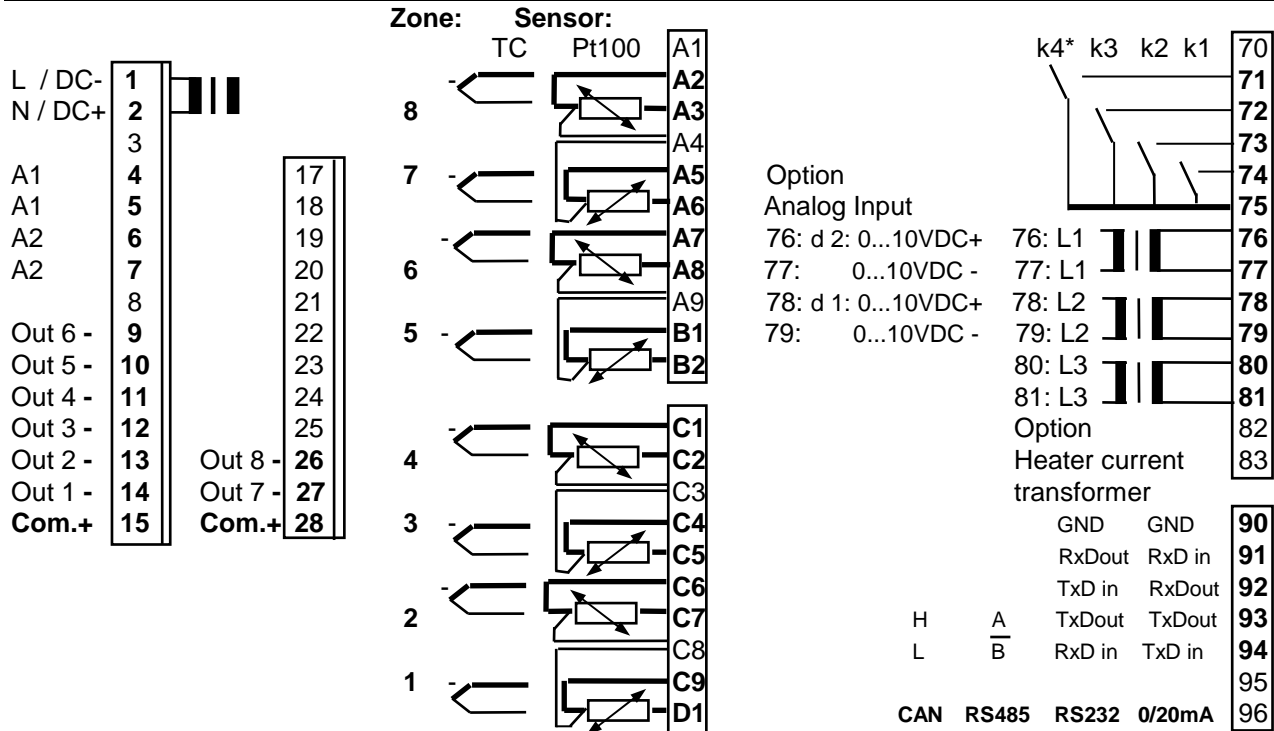

It is not permitted to connect the grounds of the sensor-inputs and bist. voltage-outputs with each other.

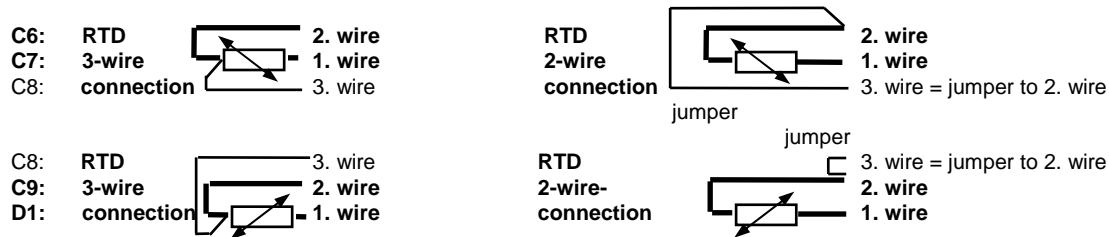

Control output OUT 1: Zone 1; control output „heating“ or „cooling“
 Control output OUT 2: Zone 2; control output „heating“ or „cooling“
 Control output OUT 3: Zone 3; control output „heating“ or „cooling“
 Control output OUT 4: Zone 4; control output „heating“ or „cooling“
 Control output OUT 5: Zone 5; control output „heating“ or „cooling“
 Control output OUT 6: Zone 6; control output „heating“ or „cooling“
 Control output OUT 7: Zone 7; control output „heating“ or „cooling“
 Control output OUT 8: Zone 8; control output „heating“ or „cooling“

Alarm Output A1: Alarm 1 (Temperature- or heater current monitoring alarm A1 for all zones)
Alarm Output A2: Alarm 2 (Temperature- or heater current monitoring alarm A2 for all zones)

Input d1: 0 ... 10 Vdc, OPTION Zone: d1
Input d2: 0 ... 10 Vdc, OPTION Zone: d2

Setpoint Controlling: K1: open = Setpoint 1 (SP1) valid
 K1: closed = Setpoint 2 (SP2) valid, for all zones

Adjustment lock (LOC): K2: open = Adjustment lock only via „software code“ (see parameter: LOC)
 K2: closed. = Adjustment locked according to the choosen „software code“.

Setpoint changing: K3: open = individual setpoint adjustment for each zone
 K3: closed = if setpoint has been changed in one zone, this new setpoint is valid (will be overtaken) for all other zones automatically.

CAN-Interface: K4: open = CAN: „operational“. Operation only with CANopen protocoll.
 K4: closed = CAN: „operational“ always active.
 „k4“ must be closed, if the instrument is equipped with a CAN-interface but not used.

Heater current monitoring: 1 current – transformer / phase
 Single phase operation: terminals 76,77: L1
 Three-phase operation: terminals 76 – 81: L1, L2, L3

Connection Diagram: R 2100 - 626 R 2100 - 826

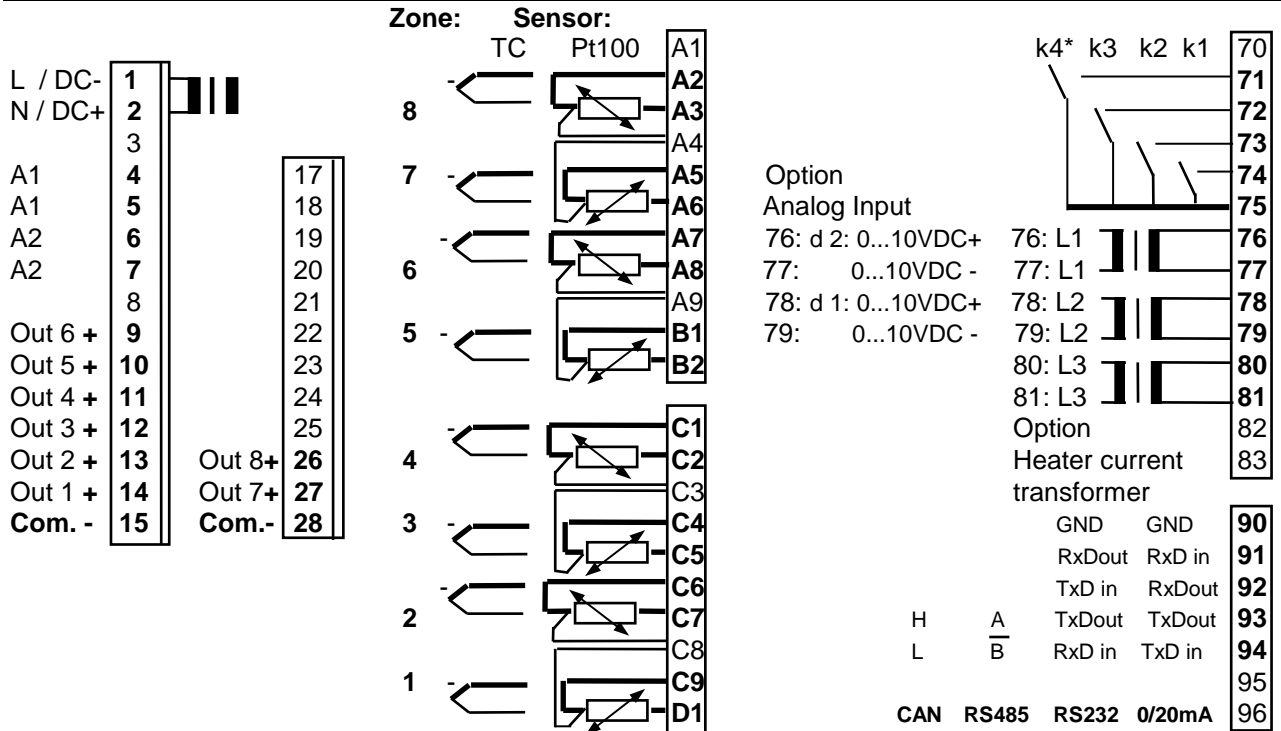

It is not permitted to connect the grounds of the sensor-inputs and bist. voltage-outputs with each other.

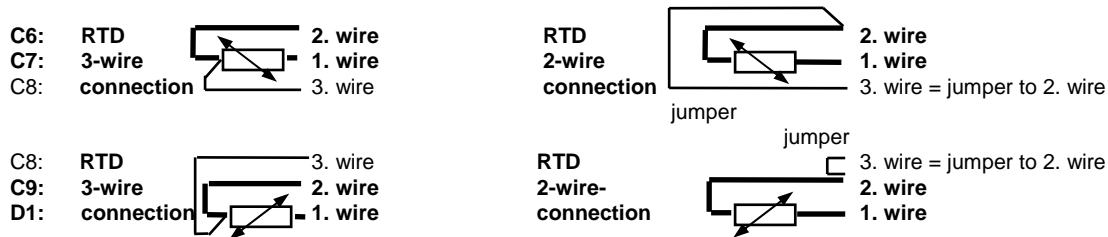

Control output OUT 1: Zone 1; control output „heating“ or „cooling“
 OUT 2: Zone 2; control output „heating“ or „cooling“
 OUT 3: Zone 3; control output „heating“ or „cooling“
 OUT 4: Zone 4; control output „heating“ or „cooling“
 OUT 5: Zone 5; control output „heating“ or „cooling“
 OUT 6: Zone 6; control output „heating“ or „cooling“
 OUT 7: Zone 7; control output „heating“ or „cooling“
 OUT 8: Zone 8; control output „heating“ or „cooling“

Alarm Output A1: Alarm 1 (Temperature- or heater current monitoring alarm A1 for all zones)
Alarm Output A2: Alarm 2 (Temperature- or heater current monitoring alarm A2 for all zones)

Input d1: 0 ... 10 Vdc, OPTION Zone: d1
Input d2: 0 ... 10 Vdc, OPTION Zone: d2

Setpoint Controlling: K1: open = Setpoint 1 (SP1) valid
 K1: closed = Setpoint 2 (SP2) valid, for all zones

Adjustment lock (LOC): K2: open = Adjustment lock only via „software code“ (see parameter: LOC)
 K2: closed. = Adjustment locked according to the choosen „software code“.

Setpoint changing: K3: open = individual setpoint adjustment for each zone
 K3: closed = if setpoint has been changed in one zone,
 this new setpoint is valid (will be overtaken) for all other zones automatically.

CAN-Interface: K4: open = CAN: „operational“. Operation only with CANopen protocoll.
 K4: closed = CAN: „operational“ always active.
 „k4“ must be closed, if the instrument is equipped with a CAN-interface but not used.

Heater current monitoring: 1 current – transformer / phase
 Single phase operation: terminals 76,77: L1
 Three-phase operation: terminals 76 – 81: L1, L2, L3

Display and Keyboard, general

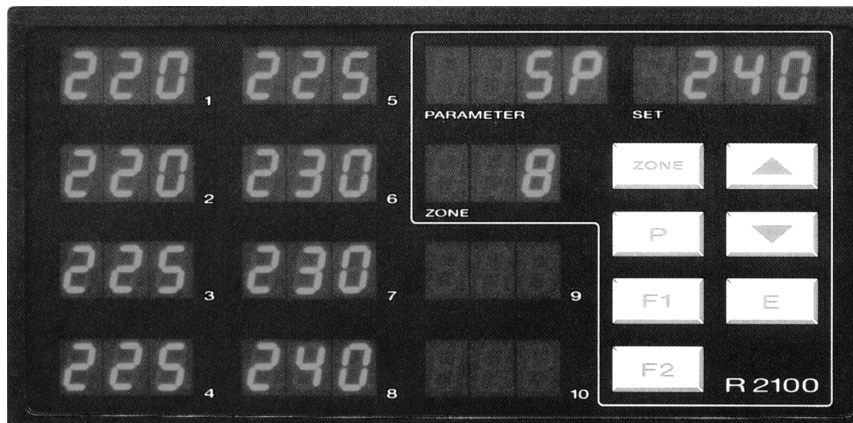

- | | |
|--|--|
| Display 1: Zone 1, actual (process) value or setpoint or tendency display heater current display | Display 5: zone 5, actual (process) value or setpoint or tendency display heater current display |
| Display 2: Zone 2, actual (process) value or setpoint or tendency display heater current display | Display 6: zone 6, actual (process) value or setpoint or tendency display heater current display |
| Display 3: Zone 3, actual (process) value or setpoint or tendency display heater current display | Display 7: zone 7, actual (process) value or setpoint or tendency display heater current display |
| Display 4: Zone 4, actual (process) value or setpoint or tendency display heater current display | Display 8: zone 8, actual (process) value or setpoint or tendency display heater current display |

Display „**ZONE**“: With key „**ZONE**“ preselected controlling zone.
Zone = 0: simultaneous indication of the above parameters.

Display „**PARAMETER**“: Shortform of the actual selected parameter.

Display „**SET**“: Parameter value

- | | |
|-------------|--|
| ZONE | Zone preselection |
| P | Parameter key (parameter preselection) |
| | Adjustment of chosen parameter (e.g. setpoint) to higher or lower values.
Short operation: single-step adjustment
Longer operation: quick-scanning |
| | When the parameter adjustments have been altered but not entered, the display will flash bright/dark. |
| E | Enter. Confirmation and storage of the pre-selected values.
The display will show a light chain as a control of this function. |
| P | Sets the parameter back to the originally stored value.
Any alterations made to the parameters, that are not confirmed (E-key) within 30 seconds, will not be accepted and the parameter will return to its originally stored value. The actual process value and the setpoint value will be indicated. |
| F2 | Function key F2, Preselection of the values displayed in the displays 1...8 simultaneous.
All actual (process) values, actual setpoints or tendency displays. |
| F1 | Function key F1, The function of this key can be programmed into the configuration level of zone 0. See parameter „Co.F1“ (page 12). |

Display: Process values, setpoints; tendency, control output and alarm indication

After switching on the unit, the process values (actual values) of zones 1...6 or 1...8 will be displayed simultaneously::

Zone 1: process 1	Zone 5: process 5	Pr. PARAMETER	SET	Pr.: Pr: Process value
Zone 2: process 2	Zone 6: process 6	0		
Zone 3: process 3	Zone 7: process 7	ZONE		
Zone 4: process 4	Zone 8: process 8			

Press key F2: Display switches over to setpoint indication (= actual setpoint SP1 or SP2) zones 1...6 or 1...8:

Zone 1: setpoint 1	Zone 5: setpoint 5	SPx PARAMETER	SET	SPx: SP1: Setpoint 1 SP2: Setpoint 2
Zone 2: setpoint 2	Zone 6: setpoint 6	0		
Zone 3: setpoint 3	Zone 7: setpoint 7	ZONE		
Zone 4: setpoint 4	Zone 8: setpoint 8			

Press key F2: Display switches over to tendency-, control output and alarm indication. Zones: 1...6 or 1...8:

Zone 1: a1-te-a2 1	Zone 5: a1-te-a2 5	tEn. PARAMETER	SET	tEn.: te: tendency and control output a1: alarm indication A1 a2: alarm indication A2
Zone 2: a1-te-a2 2	Zone 6: a1-te-a2 6	0		
Zone 3: a1-te-a2 3	Zone 7: a1-te-a2 7	ZONE		
Zone 4: a1-te-a2 4	Zone 8: a1-te-a2 8			

Press key F2: Display switches over to heater current value indication. Zones: 1...6 or 1...8:

Zone 1: current 1	Zone 5: current 5	Cur. PARAMETER	SET	Cur.: Cur.: Actual heater current values of zones 1-6 or 1-8.
Zone 2: current 2	Zone 6: current 6	0		
Zone 3: current 3	Zone 7: current 7	ZONE		
Zone 4: current 4	Zone 8: current 8			

Interpretation of the symbols: see next page

Press key F2: Display switches back to process value indication. Zones: 1...6 or 1...8:

Tendency, control output and alarm indication

With the help of key „F2“ a temperature tendency display will be shown, to give an overview about the temperatures deviations relating to the setpoints, the activity of the control outputs and an alarm indication in the individual controller zones.

For each zone are 3 digits available (displays 1...8) :

Digit a1: Indication = 1, if alarm message A1 is active in this zone.

Digit te: Temperature tendency digit.

Digit a2: Indication = 2, if alarm message A2 is active in this zone.

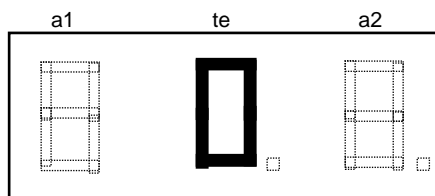
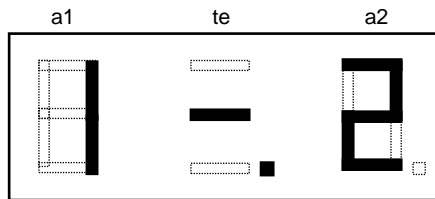

O =
Self tuning algorithm (Opt.) : active

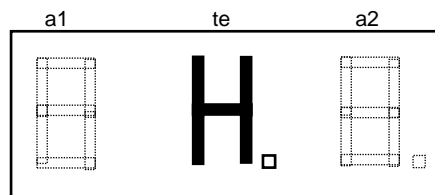

H = Manual mode (Hand)
Dec.-point flashed acc. to the actual output ratio

The symbols in digit „te“ (Temperatur tendency) have to be interpreted as follows:

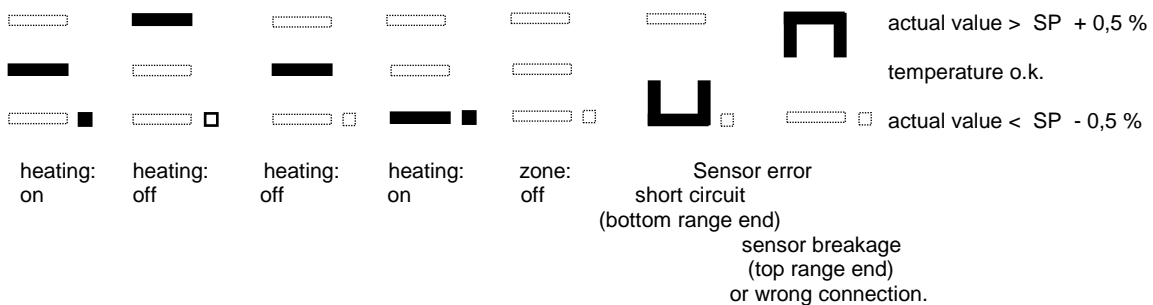

The flashing dec.-point shows, that the control output is active.

Operating Levels

The operation of the controller is divided into 3 levels.
In zone 0 general settings have to be made.

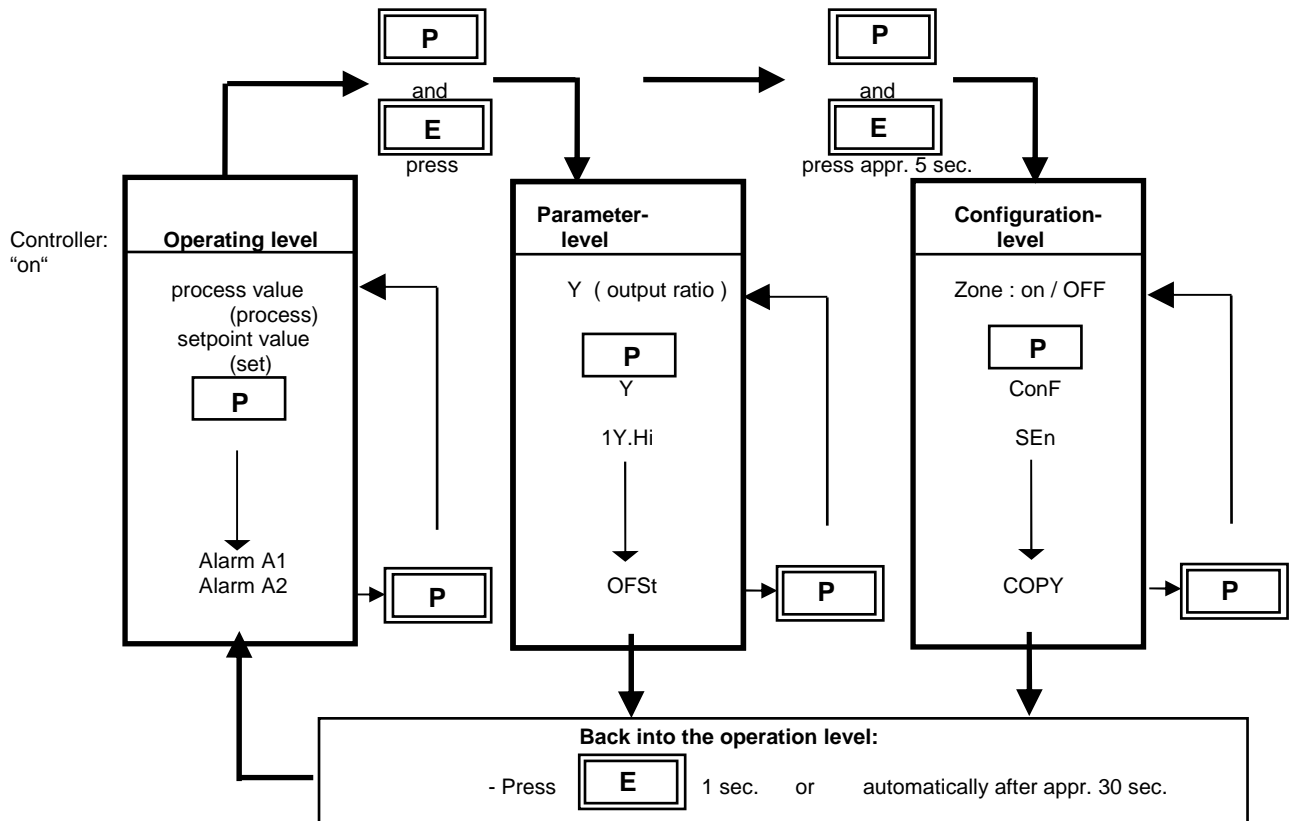

Operating level (for each zone separately):

Process- and Setpoint value will be displayed simultaneously. Within the operating level the setpoint can be adjusted by pressing the "▲"/"▼" - keys.

Every adjustment has to be quit by pressing the „E“ - key.

All parameters within the operating level (including the alarm values) can , in succession, be displayed by pressing the „P“ - key and adjusted by pressing the "▲"/"▼" - keys. Quit by pressing the „E“ - key.

Parameter level (for each zone separately):

Within the parameter level the values are adjusted to suit each individual process.

This level is reached by simultaneously pressing the "P" - and "E" -keys.

The display of each single parameter within the parameter level and their adjustment, are made in the same fashion as within the operating level.

After either pressing the „E“ - key for approx. 1 second, or waiting for a period of approx. 30 seconds, the unit will automatically return to the operating level (display of process value and setpoint).

Configuration level: This primary informations have to be entered before taking the instrument into operation.

The configuration level is reached by simultaneously pressing the "P" - and "E" - keys for a period of approx. 5 seconds.

First choose the configuration level in zone 0. Here general settings have to be made.

This has to be programmed at first:

- Only TC- or RTD-connection for all zones? Or: Mixed connection ?
- Alarm configuration (valid for all zones) - Function of key „F1“
- Software key - Serial interface informations
- Heater current monitoring system

Then choose the configuration level of each individual controller zone.

This has to be programmed at second:

- Controller type (for each zone)
- Input type (sensor type), sensor range (for each zone)
- Min. and max. setpoint range (for each zone)

The display of each single parameter within the configuration level and their adjustment, made in the same fashion as within the operating level.

There is also a copy function available. So it is possible, to copy the programmed parameters of one zone to other zones.

After either pressing the „E“ - key for approx. 1 second, or waiting for a period of approx. 30 seconds, the unit will automatically return to the operating level (display of process value and setpoint).

Configuration Level, general

(select zone 0 and press „P“ - and „E“ - key appr. 5sec.,
general settings)

Display "PROCESS"	Parameter	Display „SET“
P - tc	Sensor mix	- 8,6 all 8,6 zones: prepared for thermocouple - connection 2 x Zones 1 - 2 : RTD - connection; other zones: Thermocouple connection 4 x Zones 1 - 4 : RTD - connection; other zones: Thermocouple connection 6 x Zones 1 - 6 : RTD - connection; other zones: Thermocouple connection 8,6 - all 8,6 zones: prepared for RTD - connection
Co.A1	Alarm 1-Configuration (switches relay A1)	The selected configuration is effective for all control zones. The individual temperature alarms A1 of all zones are connected to the main, common contact A1. If a control zone indicates a fault (sensor short circuit / break), the alarm output A1 is generally switched.
		OFF alarm OFF, no alarm signalisation (ex works) 1 signal contact, setpoint dependent: off-on 2 limit contact, process value dependent: off-on 3 limit comparator: off-on-off 4 signal contact: on-off 5 limit contact: on-off 6 limit comparator: on-off-on 7 limit comp. with start-up suppression: off-on-off 8 heater current monitoring; limit contact: off-on; see page 11 9 heater current monitoring; limit contact: on-off; see page 11

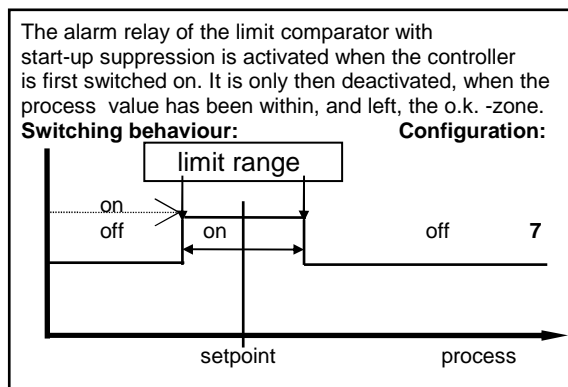
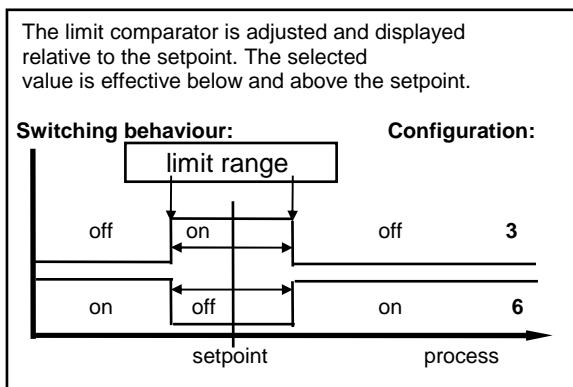
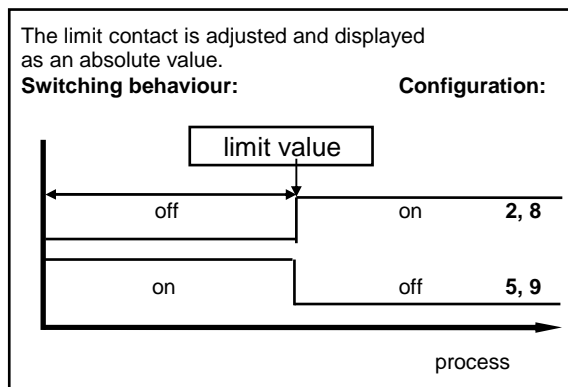
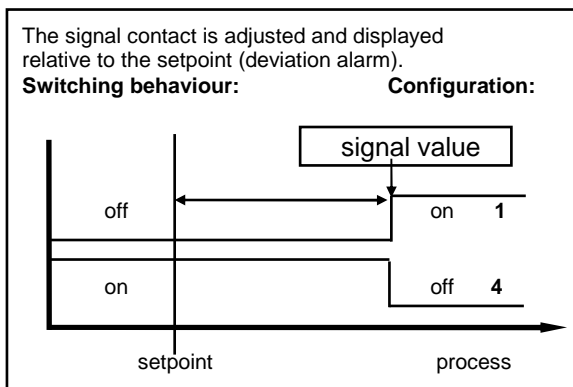

Please note:

In case of sensor error the alarms will react in the same way as range override. The alarm contacts therefore do not offer protection against all types of plant breakdown. With this in mind, we recommend the use of a second, independent monitor unit. Care should be used to ensure, that the setpoints of the alarm contacts are programmed within the selected measuring range. If a setpoint ramp has been programmed, the alarms that are relative to the setpoint (signal contact, limit comparator) follow the setpoint up the ramp.

Display "PARAMETER"	Parameter	Display „SET“			
rE.A1	Relay A1 switching behaviour	dir	on:	LED = „1“	Relay A1 "activated"
			off:	LED = „1“	Relay A1 "not active"
		inv	on:	LED = „1“	Relay A1 "not active"
			off:	LED = „1“	Relay A1 "activated"
Co.A2	Alarm 2-Configuration (switches relay A2)	see Co.A1 (alarm 1 - configuration)			
rE.A2	Relay A2 switching behaviour	dir	on:	LED = „2“	Relay A2 "activated",
			off:	LED = „2“	Relay A2 "not active",
		inv	on:	LED = „2“	Relay A2 "not active",
			off:	LED = „2“	Relay A2 "activated",

Heater current monitoring

The following parameters will only be displayed if the heater current monitoring system is activated as described below:

Heater current monitoring via relay A1: Program parameter Co.A1 to number 8 or 9
 Heater current monitoring via relay A2: Program parameter Co.A2 to number 8 or 9

The heater current to be monitored, has to be programmed as an absolute value into the operating level for both relays A1 and A2.
 See: Operating level, Parameter „A1“ or „A2“.

Please note if the supply voltage is low the heater current is higher than the monitoring value otherwise the alarm signal will be activated.

If the heater current value falls below the monitoring value, an alarm signal (the relay switches) will be activated.

With the help of the parameter „dL.Ax“ it is possible to program a delay time.

If you do so, it is virtually impossible to get an unauthorized alarm signal.

When switching the power-on, the alarm signalisation will be suppressed until the heating current values for all zones has been scanned and verified.

The monitoring function and all possible adjustments are valid for all connected heating zones.

Display „PARAMETER“	Parameter- description	Parameter value Display „SET“	
dL.A1	delay time, relay A1 If alarm relay A1 is selected for the heater current monitoring.	5 steps adjustable (in sec.) OFF= no delay time	Adjustment and display in seconds. The values are dependent on the current detection interval time and the number of active controller zones.
dL.A2	delay time, relay A2 If alarm relay A2 is selected for the heater current monitoring.	5 steps adjustable (in sec.) OFF= no delay time	Adjustment and display in seconds. The values are dependent on the current detection interval time and the number of active controller zones.

Display „PARAMETER“	Parameter-description	Parameter value	Display „SET“
Cu.CY	Current detection intervall	1 ... 60 sec.	Time between the current measuring of two zones following each other.
C x.x	Min. leakage current value and leakage current display with continous current display.	OFF; 0,0...99,9 A	Adjustment of the allowed min. leakage current value. The heater current will be monitored to detect circuits with an eventual leakage current (e.g. SSR damage).

SSR's (especially if they are combined with RC-combinations) normally have small leakage currents. Heaters also have small leakage currents.

The actual leakage current will be displayed in display „PROCESS“.
Via display „SET“ the min. allowed leakage current value can be adjusted.
Currents below this value will be ignored.

If a permanent current is detected in one zone the alarm relay will be activated and the display „PROCESS“ will show the error signalisation „Er.Cu“.
The zone with a measured permanent current can be located by pressing the zone key and watching all temperature indications.
Display indication in this case: „Comparable with„temperature too high.“
But there is no special indication via tendency- or alarm status display.

Display:

<div style="border: 1px solid black; padding: 2px; display: inline-block;">C 0.2</div> PARAMETER Leakage current: 0,2A	<div style="border: 1px solid black; padding: 2px; display: inline-block;">1.0</div> SET Min. leakage current value: 1,0A
<div style="border: 1px solid black; padding: 2px; display: inline-block;">Er. Cu</div> PARAMETER Permanent current detected in one zone. Error signalisation: flashing	<div style="border: 1px solid black; padding: 2px; display: inline-block;"></div> SET

Display „PARAMETER“	Parameter-description	Parameter value	Display „SET“
Co.F1	Select funktion of key „F1“	OFF OPt Y LEd.t	No function Selftuning algorithm can be activated by pressing key „F1“ in the matching zone. „F1“ and „E“: stop selftuning. Shows the actual percentage output ratio, while pressing „F1“. Display „PARAMETER“: Y Lamp (LED) test, while pressing „F1“.
LOC	Adjustment lock	OFF P C n.SP1 ALL	No adjustment lock (ex works) Parameter and configuration levels locked All parameters apart from SP1 locked (not SP1) All parameters locked All parameters that have been locked with „LOC“ can be selected and read, but not altered. This adjustment cannot be changed if the external contact K2 is closed.
Zo.OF	Zones offset preselection (Continuous numbering of the controller zones)	OFF 1 - 91 (8-Zo.) 1 - 93 (6-Zo.)	No offset preselection. Zones indication: 1-6 oder 1-8 Zones will be numbered with preselected offset value. For example : Zo.OF = 1 -> Zone indication: 2-7 oder 2-9 Zo.OF = 4 -> Zone indication: 5-10 oder 5-12

The following parameters are only valid, if the unit is equipped with a serial interface.
RS232, RS485, 0/20mA.

Prot	Protocol preselection	ELO IbS	ELOTECH- standard protocol Gateway-protocol valid for InterBus-S Only with RS 485-interface (Code-No.: 4).
Adr	Unit address	1 255	(ex works: 1) The computer addresses the unit/controller at this address. Each unit has ist own address. With RS-485 it is possible to address 32 units.
For	Data format	7E1 7o1 7E2 7o2 7n2 8E1 8o1 8n1 8n2	7 data, even, 1 stopbit 7 data, odd, 1 stopbit 7 data, even, 2 stopbit 7 data, odd, 2 stopbit 7 data, none, 2 stopbit 8 data, even, 1 stopbit 8 data, odd, 1 stopbit 8 data, none, 1 stopbit 8 data, none, 2 stopbit InterBus-S
bAud	Baud rate	OFF; 0,3 ... 9,6 kBaud	The baud rate denotes the transmission rate at which one bit is transmitted. InterBus-S = 9,6 kBaud
	Details:	See:	- sep. interface description: ELOTECH – standard-protocol - sep. interface description: Gateway: M-IBS-5

The following parameters are only valid, if the unit is equipped with a CAN interface.

Adr	Unit address	1 127	(ex works: 1)
bAud	Baud rate	10, 20, 50, 100, 125, 250, 500k, 1000k Baud	(ex works: 20)
	CANopen-specification:	CANopen Master: CANopen Slave: Extended Boot-up: Minimum Boot-up: COB ID Distribution: Node ID Distribution: No. of POD's: PDO Modes: Variable PDO mapping: Emergency message: Life guarding: No. of SDO's: Device Profile:	no yes no yes yes; default via SDO no; via device keyboard 0RX, 1TX async. no yes yes 1RX, 1TX CiA DS-404
	Details:	See:	CANopen Device Profile CiA DS-404; ELOTECH Object Dictionary

21xx EL.xx	Control number	No function. End of configuration level
-----------------------------	-----------------------	---

Configuration Level

Individual selectable for zones 1 ... 8
(select zone and press „P“ - and „E“ - key appr. 5sec.)

Display "PARAMETER"	Parameter	Display „SET“	
Zone	Zone on / off	OFF on	measuring- or controller zone „off“ measuring- or controller zone „on“
ConF	Controller configuration	2P h 2P c 2Pnc diSP	2-point-controller „heating-off“ (ex works) 2point-controller „cooling-off“ 2point-controller „cooling-off“ with non-linear cooling *) *) non-linear cooling: Cooling action can be pre-selected with either linear or non-linear cooling response curve (e.g. for vapour cooling). Zone works as an indicator, no controller action
SEn	Sensor selection	P1 °C P1 °F P2 °C P2 °F P4 °C P4 °F P8°C	Pt 100, 0,0 ...99,9 °C Pt 100, 32 ...212 °F Pt 100, -100 ...+100 °C Pt 100, -148 ... +392 °F Pt 100, 0 ... 400 °C (ex works) Pt 100, 32 ... 752 °F Pt 100, 0 ... 800 °C

or, if selected as a thermocouple-input zone (depending on parameter „P - tc“ in Zone 0):

L4 °C	T/C Fe-CuNi (L),	0 ... 400 °C
L4 °F	T/C Fe-CuNi (L),	32 ... 752 °F
L8 °C	T/C Fe-CuNi (L),	0 ... 800 °C
J8 °C	T/C Fe-CuNi (J),	0 ... 800 °C
n1 °C	T/C NiCr-Ni (K),	0 ... 999 °C

If the Sensor selection is changed, the following parameters will be set as follows and need to be re-adjusted:

Setpoint 1, setpoint 2:	SP.Lo	Process value offset:	OFF
Lower setpoint limitation:	Bottom range end;	Higher setpoint limitation:	Top range end;
Setpoint-ramp values:	OFF;	Alarm values:	OFF;

OPTION: The following parameters are only valid for zones d1 and d2 (Input: 0...10 Vdc).
It is to configurate the display range of the 0...10 Vdc inputs.
The difference between the bottom end of the display range and the top end must amount to a minimum of 100 units and a maximum of 2000 units. By adjustment of one of the above parameters, the other in this case will automatically follow.

unit	selectable physical. unit	Shown in the display „parameter“, when zone d1 or d2 selected (e.g. : °C, °F, bar, volt ...). Display „s et“ shows additional the actual value.
rA.dP	decimal points	0; 1; 2 (ex works: 1)
rA.Hi	display range top end	rA.Lo ... 9999 (ex works: 100,0)
rA.Lo	display range bottom end	-1999 ... rA.Hi (ex works: 0,0)

SP.Hi **higher setpoint limitation** programming range: SP.Lo ... top range (ex works: 400)

SP.Lo **lower setpoint limitation** programming range: bottom range ... SP.Hi (ex works: 0)

COPY **Copy function** to 1 ... to x
Copy all configuration datas of the actual zone 1 to zone x.
Select the target zone 1, 2 or „to A“ (all) with the „up/down“ - keys and press „E“ (enter). After this, the datas would be copied.
Note: It is only possible to copy the configuration, if the sensor configuration (Parameter: P - tc) in the target-zone is the same as in the actual zone. This means, that it is not possible, to copy configurations of e.g. RTD-input zones to thermocouple-input zones.

Softstart-function

TAKE CARE: If you take the softstart-function, make sure that the instrument is equipped with bistable voltage (logic) outputs. This function is not allowed for instruments with relay-outputs (in this case set So.St = OFF). Otherwise the relais will switch too fast.

Softstart (general function):

During the softstart the controllers' heating output response is limited to a pre-selected ratio, in order to achieve a slow baking out of high performance heat cartridges.

Simultaneously the output clock frequency is quadrupled. Once the process value reaches the softstart setpoint, it remains stable at this value for a pre-selected hold-duration time.

At the end of this period the process value rises to the valid setpoint.

This results in a slower, more regular heating period.

For this purpose the bistable voltage output must be taken, that actuates SSR relays.

If the softstart is active, the controllers' autotune function can't operated (Er.OP).

If a setpoint-ramp has been programmed, the softstart has priority, and the ramp will only become active after the softstart has been completed.

The softstart only works,

- if the parameter „1 P“ (prop. band, xp) is programmed > 0,1%.

- if the actual process value is lower than So.SP – 5% of the selected measuring range.

It is possible, to select this function for each zone individually.

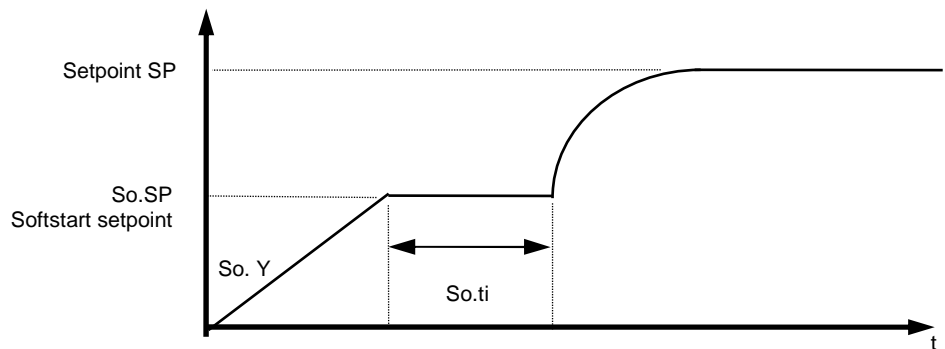

So.St	Softstart-function	<p>OFF: Softstart not active (ex works) Next parameter So.Y, So.SP, So.ti are not shown.</p> <p>On: Softstart in action. The softstart function always runs, if the controller is switched on and / or if the actual temperature is below the softstart setpoint So.SP minus 5% of the range (e.g. range: 400°C -> 5%= 20°C).</p>
So. Y	Softstart output ratio	10 ... 100%
So.SP	Softstart setpoint	range: SP.Lo SP.Hi
So.ti	Softstart duration time	OFF; 0,1 ... 10,0 min.

Display "PARAMETER"	Parameter	Display „SET“	
Hand	manual output ratio	OFF, Auto, Man	(ex works: OFF)

Setting: OFF
Function not active

Setting: Auto

In event of sensor break the controller automatically maintains the last valid output ratio as the actuating signal.

An „H“ is then displayed as the first digit in the setpoint display, followed by the valid output ratio. This ratio can be manually altered in steps of 1% (up/down-keys; enter).

Under the following circumstances, the output ratio will be 0%:

- if the output ratio at time of the sensor break was 100%.
- if the controller is working along a setpoint-ramp.
- if the control deviation was more than 0,25% of the total range at the time of sensor break.
- if the prop. band ($P; x_p$) = 0.
- if the soft start was active at the time of the sensor break.

A few seconds after the sensor break has been rectified, the controller returns to automatic operation and calculates the required output ratio.

An additional signal can be issued in the event of sensor break, if the alarm contacts are programmed accordingly.

Setting: Man

The controller now operates only as an actuator. Within the operation level, an output ratio can be entered instead of the setpoint. An „H“ is then displayed as the first digit in the setpoint display, followed by the output ratio. There is no controlling action.

Parameter Level

Individual selectable for zones 1 ... 6 / 8
(select zone and press „P“ - and „E“ - key appr. 1sec.)

Display "PARAMETER"	Parameter	Display „SET“	
Y	valid output ratio	-100...100 %	The output ratio shows the momentary calculated ratio. It cannot be altered. The display is in percent of the installed performance capability for heating or cooling. Output ratio for cooling is shown as a negative value.
1Y.Hi	output ratio limit „heating“	0...100 % (ex works: 100)	Limitation of the output ratio is only necessary when: the heating or cooling energy supply is grossly over-dimensioned compared to the power required, or to turn off a control output (setting = 0%). Under normal circumstances no limitation is needed (setting = 0%). The limitation becomes effective, when the controllers' calculated output ratio is greater than the maximum permissible (limited) ratio. Warning! The output ratio limitation does not work during autotune.
2Y.Hi	output ratio limit „cooling“	0...100 % (ex works: 100)	Only types: R2100-63x and R2100-83x and Configuration: heating-off-cooling controller
1 P	Xp, prop.-band (P) „heating“	OFF; 0,1...100,0 % (ex works: 3,0)	If „ 1 P “ = OFF (control action: on-off, without feedback) next parameter: „ 1 sd “.
1 d	Tv, rate (D) „heating“	OFF; 1...200 secs (ex works: 30)	
1 J	Tn, reset (I) „heating“	OFF; 1...1000 secs (ex works: 150)	Normally the controller works using PD/I control action. This means, controlling without deviation and with practically no overshoot during start-up. The control action can be altered in its structure by making the following adjustments to the parameters: a. no control action, on-off (setting P = OFF) b. P-action (setting D and I = 0) c. PD-action (setting I = 0) d. PI-action (setting D = 0) e. PD/I modified PID-action
1 C	cycle time „heating“	0,5...240,0 secs (ex works: 10,0)	The switching frequency of the actuator can be determined by adjusting the cycle time. This is the total time needed for the controller to switch on and off once. a) Relay outputs: cycle time > 10 secs b) Bistable voltage outputs: cycle time 0,5...10 secs
1 Sd	Control sensitivity output „heating“	Only if: 1 P = Xp = OFF (On-off action, without feedback) OFF; 0,1...80,0 °C (ex works: 0,1)	

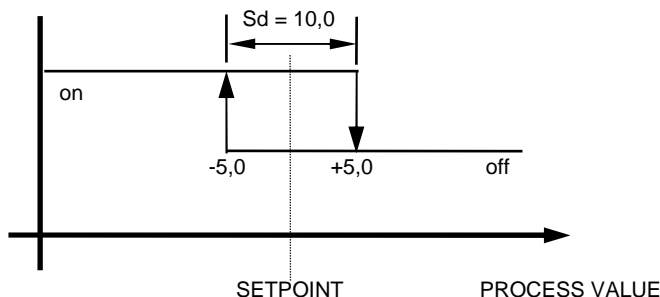

Display "PARAMETER"	Parameter	Display „SET“	
OPt	self tuning (autotune)	OFF on	self tuning out of action self tuning on request (one time)

The tuning algorithm determines the characteristic values within the controlled process, and calculates the valid feedback parameters (P,D,I) and the cycle time ($C = 0.3 \times D$) of a PD/I-controller for a wide section of the range.

The self tuning activates during start-up shortly before the setpoint is reached. The setpoint must amount to the least 5% of the total range.
If activated after the setpoint has already been reached, the temperature will first drop by approx. 5% of the total range, in order to detect the exact amplification of the process.

The tuning algorithm can be activated at any time by selecting the **OPT=on** and pressing the „E“-key. During self tuning „Opt“ is shown in the display, alternating with the setpoint value.

Self tuning activ: „SPx“ flashes with „Opt“ - indication in display „PARAMETER“.

After having calculated the correct feedback parameters, the controller will lead the process value to the setpoint.

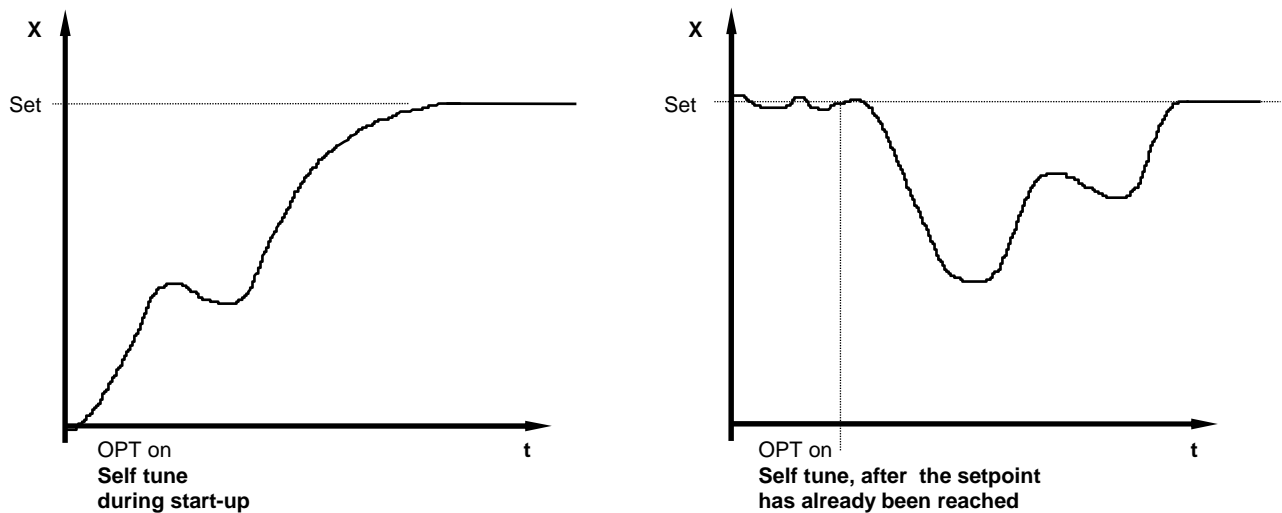

Self-tuning can be stopped by selecting the option **OPT = OFF** and pressing the „E“ - key.

OFSt	process value offset	-99 ... OFF ...100 Units (ex works: OFF) -9,9 ... OFF ... 10,0
-------------	-----------------------------	---

This parameter serves to correct the input signal, e.g. for:
- the correction of a gradient between the measuring point and the sensor tip,
- the line resistance balancing of 2-line RTD (Pt100) sensors and
- correction of the control deviation when using P- or PD-action.

If for example the offset value is set to +5°C , then the real temperature measured by the sensor (when process is balanced) is 5°C less than the setpoint and the displayed process value.

Operating Level

(individual selectable for zones 1 ... 6 / 8)

Display "PARAMETER"	Parameter	Display „SET"	
SP1	Setpoint 1 (set)	SP.Lo...SP.Hi	(ex works: 0)
SP2	Setpoint 2 The 2. setpoint is active when the external contact K1 is closed. The corresponding LED „SP2" lights up on the faceplate, and the second setpoint is shown in the setpoint-display. In order to change the value the parameter SP2 has to be selected. SP2=OFF: SP1 is still valid, if the contact K1 is closed.	OFF; SP.Lo SP.Hi	(ex works: OFF)
SP _r	rising ramp	OFF; 0,1...100,0 °C/min. or °F/min.	(ex works: OFF)
SP _f	falling ramp	OFF; 0,1...100,0 °C/min. or °F/min.	(ex works: OFF)

A programmed ramp is always activated when the setpoint is altered or when the mains supply is switched on. The ramp constructs itself out of the momentary process value and the pre-selected setpoint. If the ramp is active, the corresponding LED lights up on the faceplate. The ramp can be activated for both setpoint1 and setpoint2. By programming the second setpoint accordingly a setpoint profile can be obtained (please see example below).

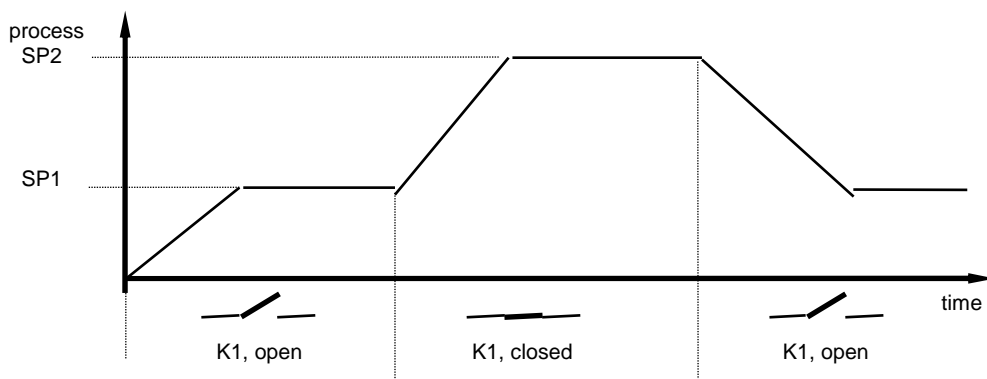

A1	Alarm value 1, switching point (switches relay A1)	Temperature monitoring: alarm value adjustment Signal contact, limit comparator, limit contact OFF; -199... 199 °C/°F OFF; -19,9... 19,9 °C/°F OFF; 0... 999 °C/°F or Heater current monitoring: alarm value adjustment Limit contact OFF: 0,0 ...99,9 A	(ex works: OFF)
A2	Alarm value 2, switching point (switches relay A2)	Temperature monitoring: Signal contact, limit comparator, limit contact OFF; -199... 199 °C/°F OFF; -19,9... 19,9 °C/°F OFF; 0... 999 °C/°F or Heater current monitoring: alarm value adjustment Limit contact OFF: 0,0 ...99,9 A	(ex works: OFF)
Cur	Heater current	Indication of the actual heater current	

The range of adjustment is dependant on the sensor, the connected current transformers and the alarm configuration. Both have to be set in the configuration level.

DISPLAY

(OPTION: only inputs zone d1 and d2 , individual display)

Analogue value	Display „Zone"	Indication	
input d1	d1	Display 9:	0...10 Vdc, corresp. the progr. range (ex works: 0...100)
input d2	d2	Display 10:	0...10 Vdc, corresp. the progr. range (ex works: 0...100)

Technical Data

Input RTD, Pt 100 (DIN):	2 - or 3 - wire connection possible. Built-in protection against sensor breakage and short circuit. Max. permissible line resistance by 3-wire connection: 80 Ohms Sensor current: ≤ 1 mA Calibration accuracy: $\leq 0,2$ % Linear error: $\leq 0,2$ % Influence of the ambient temperature: $\leq 0,01$ % / K
Input Thermocouple:	Built-in internal compensation point and protection against sensor breakage and incorrect polarity. Re-calibration not required for a line resistance of up to 50 Ohms. Calibration accuracy: $\leq 0,25$ %
Analog inputs (Option):	0 ... 10 V DC (Display range programmable)
Setpoint selection:	Ext. potential-free contact, switching voltage appr. 24 V DC, max. 1 mA. Selection between SP1 and SP2 valid for all zones.
Control outputs OUT 1 ... OUT 8:	Bist. voltage signal, 0/18 V DC, max. 10 mA, short-circuit proof or Relay, max. 250 VAC, max. 3 A (cos-phi = 1)
Alarm outputs A1 and A2:	Relay, max. 250 VAC, max. 3 A (cos-phi = 1)
7-Segment-Display:	Process: 10 mm red, Set: 10 mm red
Data protection:	EAROM
CE – mark:	Tested according to 89 / 336 / EWG EN 50081-2, EN 50082-2
Power supply:	Standard: 230 V AC, ± 10 %, 48...62 Hz, appr. 10VA
Connections:	Screw terminals, Protection mode IP 20 (DIN 40050), Insulation class C
Permissible operating conditions:	Operating temperature: 0...50 °C / 32...122 °F Storage temperature: -30...70 °C / -22...158 °F Climate class: KWF DIN 40040; equivalent to annual average max. 75 % rel. humidity, no condensation
Casing:	Format: 192 x 96 mm (DIN 43700), installation depth 122 mm Panel cutout: 186 +1,1 mm x 92 +0,8 mm Material: Noryl, self-extinguishing, non-drip, UL 94-V1 Protection mode: IP 20 (DIN 40050), IP 50 front side
Weight:	app. 800 g
Heater current monitoring:	
Current transformer 1:1000: (Type M2000)	Passive through current transformer with snap-in attachment for DIN rail mounting (EN 50022, 35mm). Connections to the controller: 2 x 6,3mm flat connectors.
Heater current detection and indication range:	0...max. 60,0A. Single-phase operation. 0...max. 99,9 A. Three-phase operation. The sum of the current of all three phases of one controller zone will be monitored. Variations of the power supply voltage have to be considered when the the alarm values are programmed.
Current detection interval time programmable (1...60 sec.).	This is the time between the measuring of two successive controller zones.
Alarm delay time programmable.	It depends upon the current detection interval time and the number of the connected temperature zones (min. 8 sec.).

Subject to technical improvements!

Error displays

Display	Cause	Possible remedy
SP.Lo	Lower setpoint limit has been reached	Reduce limit, if need be
SP.Hi	Upper setpoint limit has been reached	Increase limit, if need be
LOC	Parameter has been locked	Unlock, if need be
Er.H	Top range end has been exceeded, sensor defect	Check sensor and cable
Er.L	Bottom range end has been exceeded, sensor defect	Check sensor and cable
Er.O	Self tuning error	Extinguish error signal by pressing the „E“-key. Check the self tuning conditions and restart.
Er.SY	System error	Extinguish error signal by pressing the „E“-key. Check all parameters. If the error signal continues please send the controller for examination.
Co.A1	Alarmconfiguration of alarm A1: OFF	No alarm signal available
Co.A2	Alarmconfiguration of alarm A2: OFF	No alarm signal available
-no- -PA-	Parameter not available in this zone.	
Er.Cu	Short circuit current in one or more loads. Look at SSR's with short circuit. The zone or the zones where a permanent current is measured, can be detected by controlling the actual temperature indications of all zones. The temperature should be too high.	Check load.

Installation Instructions

Make certain that the devices described here are used only for the intended purpose.
They are intended for installation in control panels.
The controller must be installed so that it is protected against impermissible humidity and severe contamination.
In addition, make sure that the permitted ambient temperature is not exceeded.

The electrical connections must be made according to the relevant locally applicable regulations.

If using a thermocouple sensor, the compensation cables must be laid directly to the controller terminals.
Transducers must be connected only in compliance with the programmed range.

Transducer cables and signal lines (e.g. logic or linear voltage outputs) must be laid physically
separated from control lines and mains voltage supply cables (power cables).
Spatial separation between controller and inductive loads is recommended.
Interference from contactor coils must be suppressed by connecting adapted RC-combinations parallel to the coils.
Control circuits (e.g. for contactors) should not be connected to the mains power supply terminals of the controller.

IMPORTANT:

Before operation, the unit must be configured for its intended purpose under an expert guidance.
(e.g. controller type, sensor type and range, alarm adjustment etc.)
Please see „Configuration Level“.

