



ELOTECH

R2400 S with service interface

Multi-zone temperature controller

4 | 6 | 8 zone 2-point controller

4 | 6 | zone 3-point controller



Installation depth: 122 mm
Format, case: 96 x 96 mm (1/4 DIN)

DESCRIPTION AND OPERATING MANUAL

ELOTECH Industrieelektronik GmbH	
Verbindungsstraße 27	
D - 40723 HILDEN	
FON +49 2103 / 255 97 0	FAX +49 2103 / 255 97 29
www.elotech.de	Email: info@elotech.de

1 Contents

1	Contents	2
2	General Information	2
3	Installation Instructions.....	3
4	Type Code.....	4
5	Connection Diagram.....	5
	5.1 Power Supply and Outputs.....	5
	5.2 Sensor Inputs.....	8
	5.3 Additional Functions.....	9
	5.4 Fieldbus Interfaces.....	9
6	Display and Keyboard.....	10
	6.1 Window: Actual Process Values (key: "act").....	11
	6.2 Window: Tendency Display (key "trend").....	11
	6.3 Window: Zone Information (key "zone").....	12
	6.4 Window: Recorder Function.....	12
7	Parameter Descriptions.....	13
	7.1 Configuration Parameters, Valid for the Complete Device.....	13
	7.2 Zone Configuration.....	21
	7.3 Control Parameters, Zone Dependent	25
8	Service-Interface.....	30
9	Error Messages.....	31
10	Technical Data.....	32

2 General Information

Alarm	Messages shown by the controller are written in this font.
<\$>	Symbolizes the value of the factory adjustment of the respective parameters.
>3<	This parameter is available in 3-point controllers only.
<+Vers EL.02A>	For this feature firmware version EL.02A or later is required. The actual firmware version is displayed in the parameter " Device code: " (Chapter 7.1)

3 Installation Instructions

Make certain that the device is used for the intended purpose only.

R2400 controllers are designed for installation in control panels.
Protect the device against impermissible humidity and contamination.

Ambient temperature may not exceed 50 °C (122 °F).
Electrical connections must be made according to valid regulations and by properly qualified personnel.

If using thermocouple sensors, compensation lines have to be connected directly to the controller terminals. Sensors may be connected only in compliance with the programmed range.

Sensor cables and signal lines (e.g. logic or linear voltage outputs) must be laid separately from control lines and mains voltage supply cables (power cables).
It is not permitted to connect the grounds of the sensor-inputs and Logic-outputs with each other.

Separate installation of controller and inductive loads is recommended.
Interference from contactor coils must be suppressed by connecting adapted RC-combinations parallel to the coils.

Control circuits (e.g. for contactors) should not be connected to the mains power supply terminals of the controller.

The configuration parameters are generally to be selected first.

Disclaimer of Liability

We have checked the contents of this document for conformity with the hardware and software described. Nevertheless, we are unable to preclude the possibility of deviations so that we are unable to assume warranty for full compliance. However, the information given in the publication is reviewed regularly. Necessary amendments are incorporated in the following editions.

We would be pleased to receive any improvement proposals which you may have.

The information contained herein is subject to change without notice.

Electronic scrap and components are subject to special treatment and must be disposed of by authorized companies.

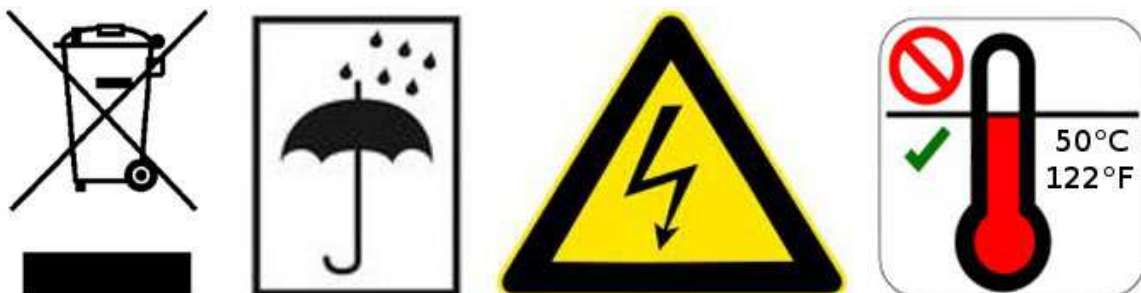

4 Type Code

R2400 - aaa - x - y - 000 - d - z

Power Supply

1	230 VAC
2	115 VAC
3	24 VAC
5	24 VDC

Fieldbus Interface

0	No
2	RS 232-C
4	RS 485
5	0/20mA TTY
7	CAN
9	Profibus-DP

Heater Current Monitoring

0	No
5	Yes (Logic outputs only)

Version

0	Standard
S	With Service-Interface

	Zones	Type	Control Outputs heating / cooling	
421	4-zones	2-point	Relay	
426	4-zones	2-point	Logic	
621	6-zones	2-point	Relay	
626	6-zones	2-point	Logic	
821	8-zones	2-point	Relay	
826	8-zones	2-point	Logic	
431	4-zones	2/3-point	Relay	Relay
436	4-zones	2/3-point	Logic	Logic
437	4-zones	2/3-point	Logic	Relay
636	6-zones	2/3-point	Logic	Logic
637	6-zones	2/3-point	Logic	Relay

5 Connection Diagram

5.1 Power Supply and Outputs

Type: 431

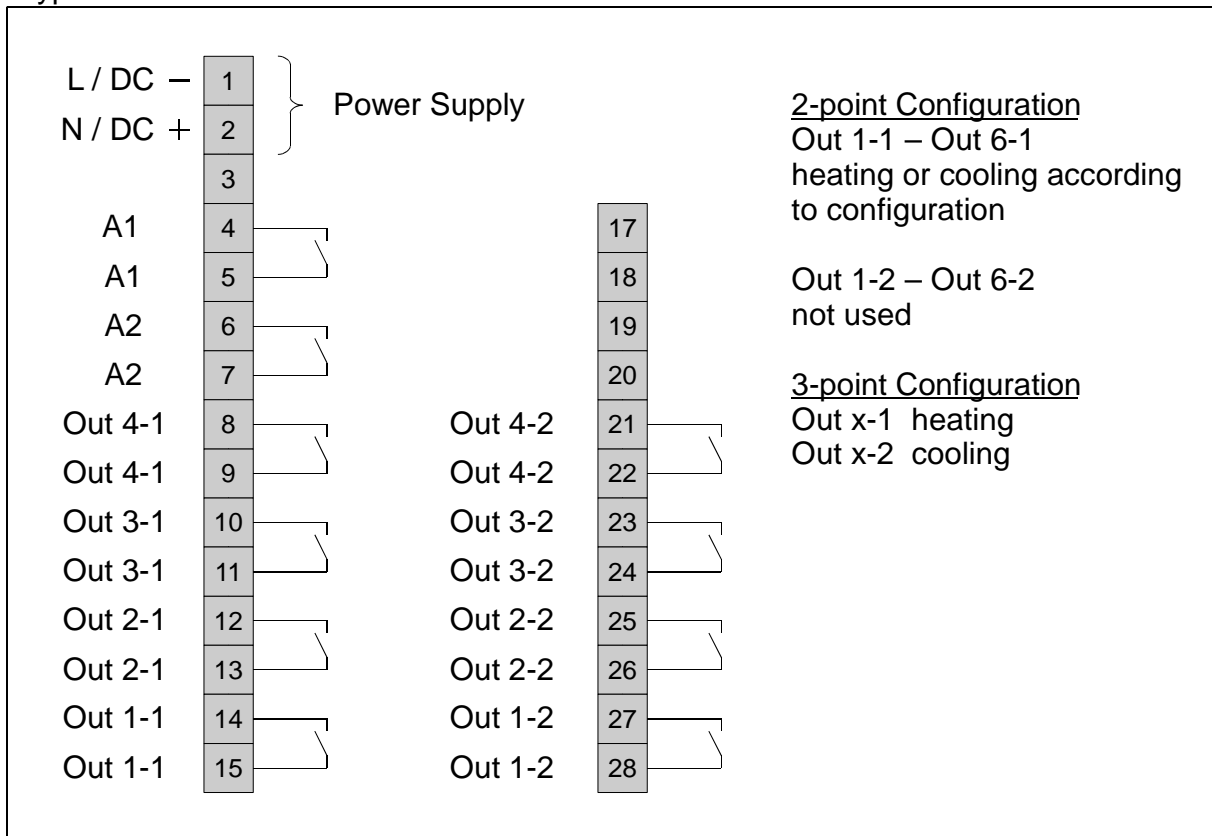

Type: 421, 621, 821

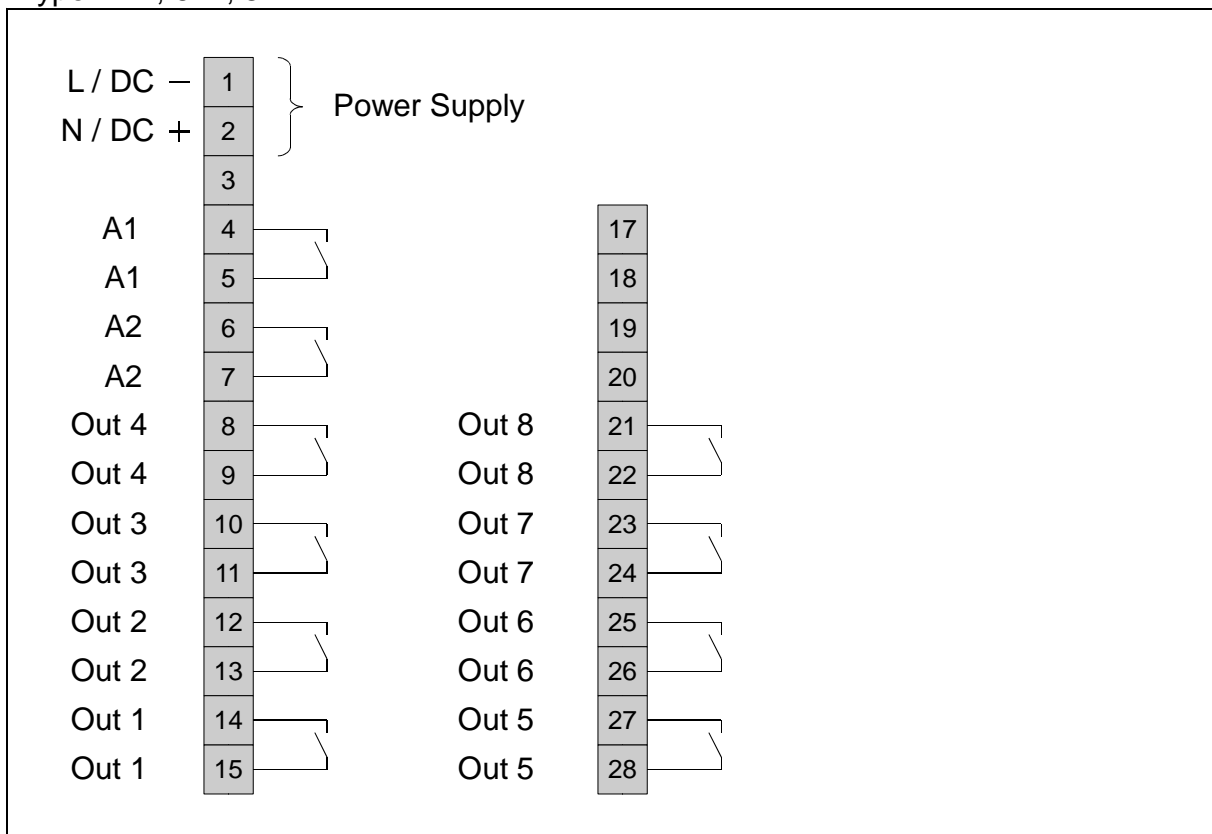

Type: 426, 626, 826

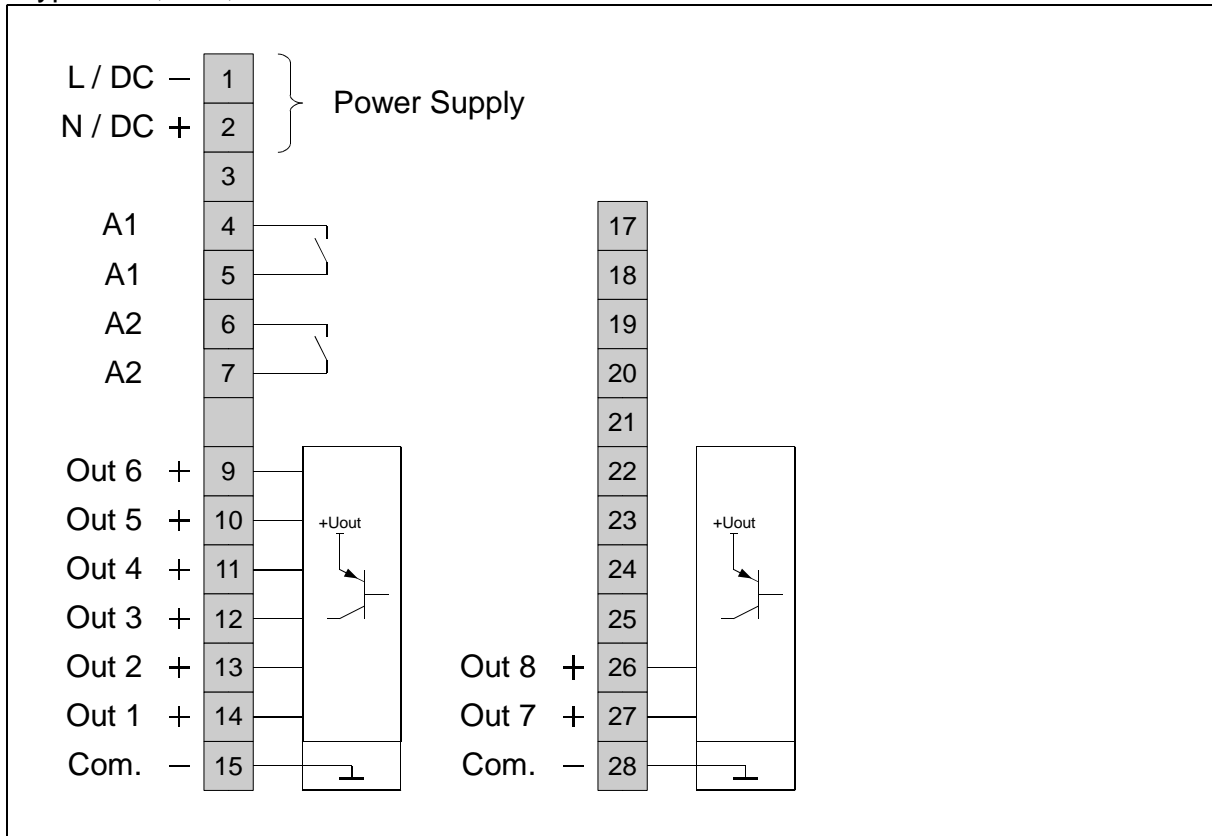

Type: 436, 636

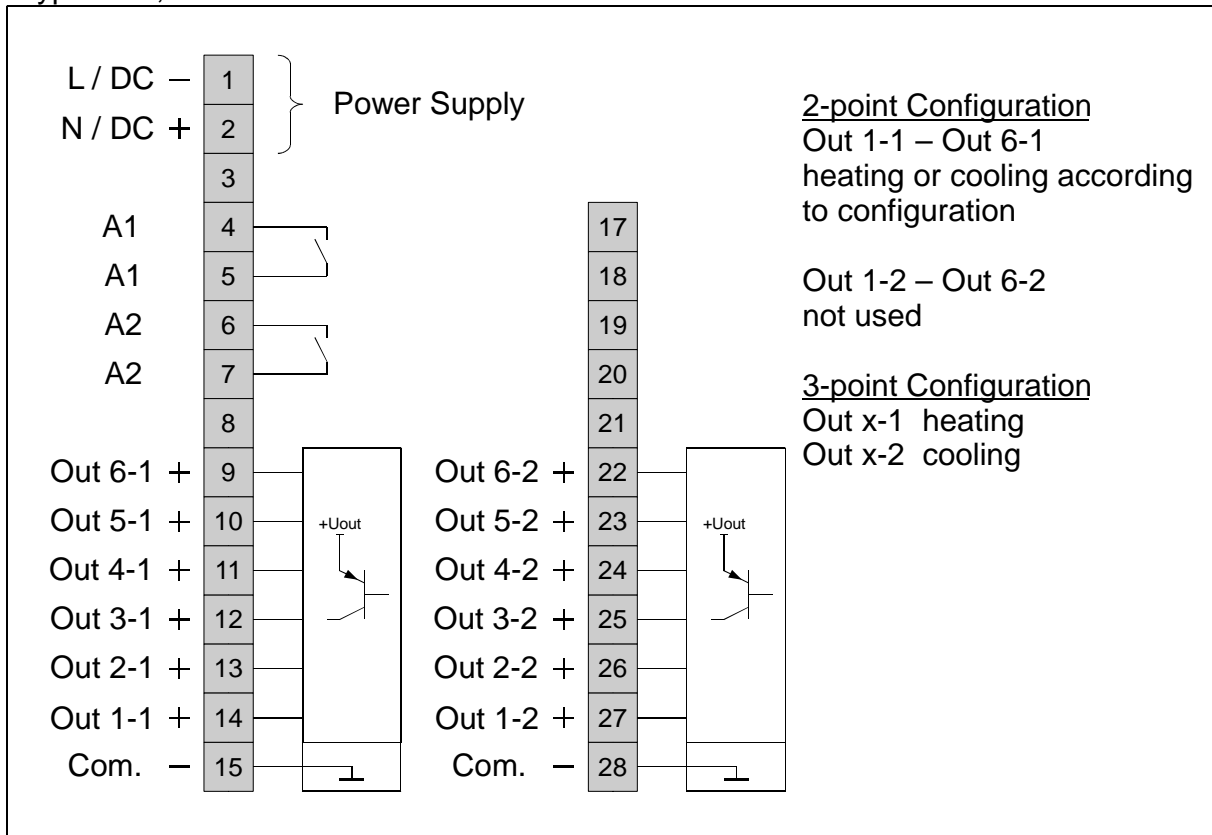

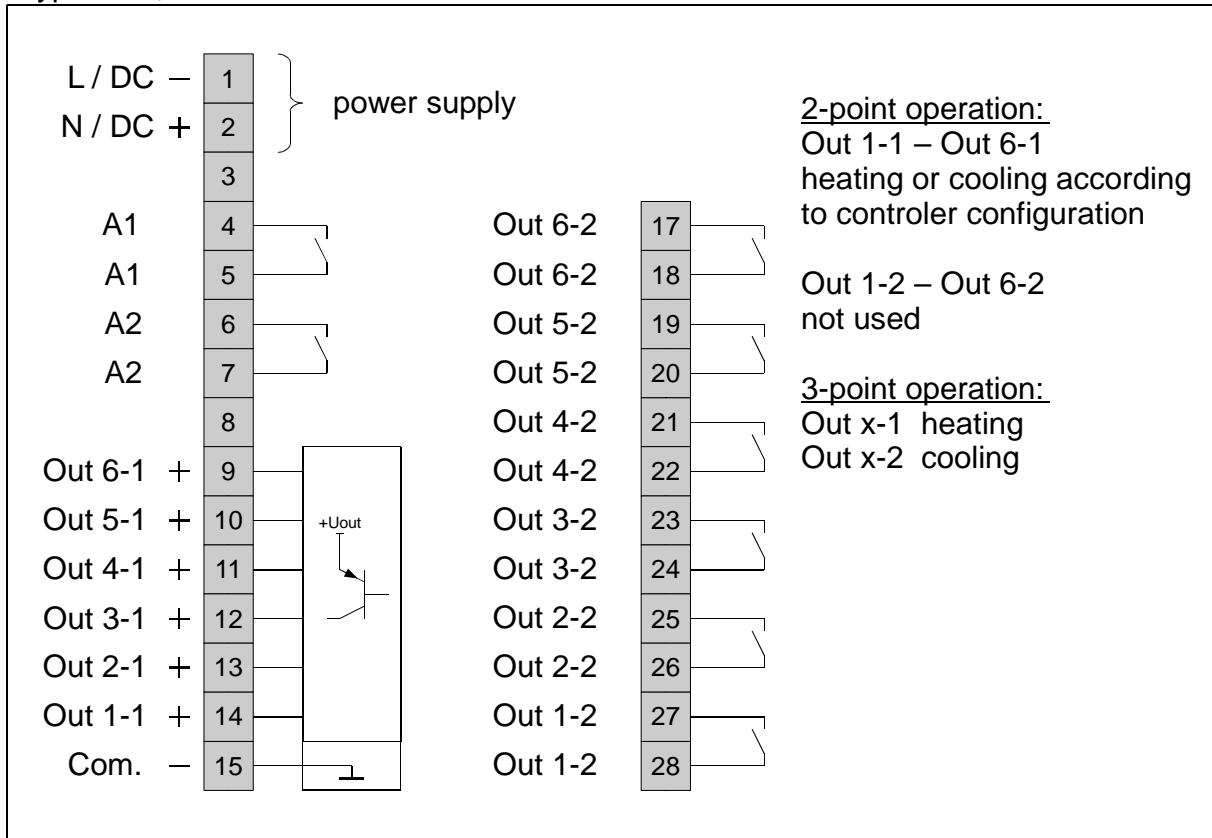

5.2 Sensor Inputs

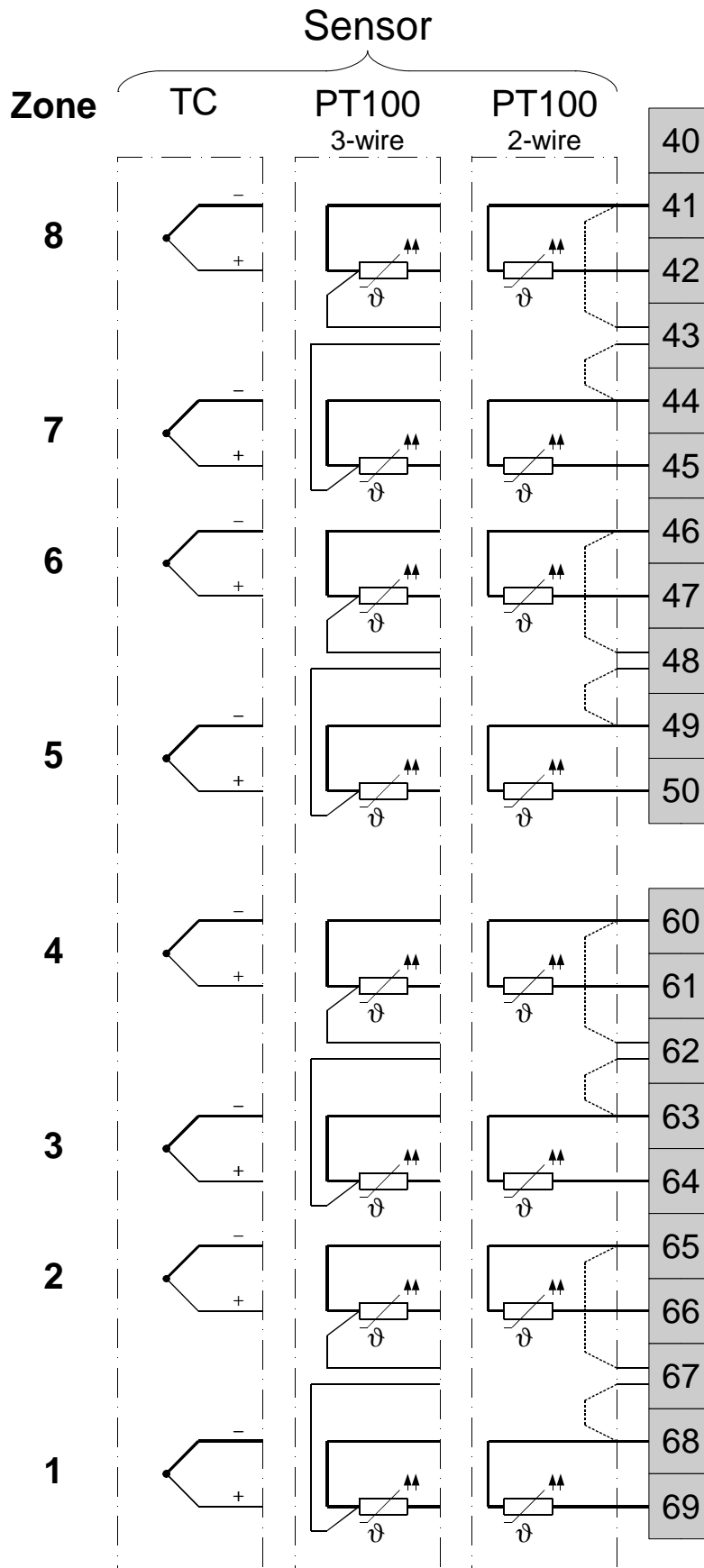

It is not permitted to connect the grounds of the sensor-inputs and Logic-outputs with each other.

5.3 Additional Functions

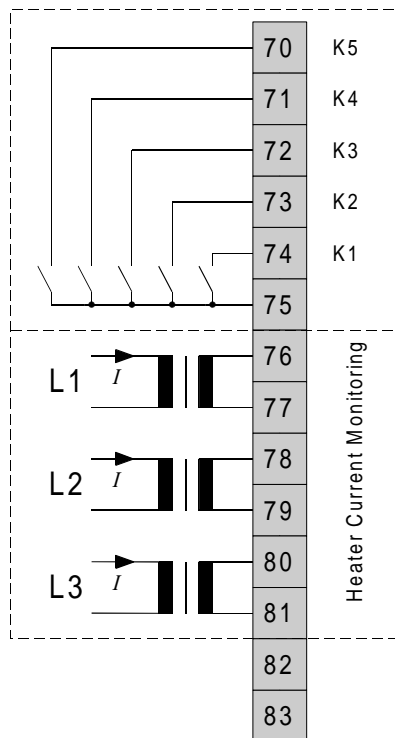

Setpoint Controlling:

K1	open	Setpoint 1 (SP1) valid, for all zones
	closed	Setpoint 2 (SP2) valid, for all zones

Adjustment lock:

K2	open	Adjustment lock off
	closed	Adjustment lock on (according to the chosen „software code“)

Setpoint changing:

K3	open	individual setpoint 1 adjustment for each zone
	closed	setpoint 1 will be overtaken for all other zones automatically

CAN-Interface:

K4	open	CAN: „operational“ Operation only with CANopen protocol
	closed	CAN: „operational“ always active

5.4 Fieldbus Interfaces

Profibus	CAN	RS 485	RS 232	TTY / 20mA	
GND			GND		90
VP +5V			RxD out	RxD in	91
CNTR			TxD in	RxD out	92
RxTx P (red)	H	A	TxD out	TxD out	93
RxTx N (green)	L	B	RxD in	TxD in	94
Service-Interface RS 485				A	95
				B	96

6 Display and Keyboard

The device is equipped with a backlight LC-display.

After switching on the device will initialize.







The actual process values of all connected zones are displayed.

The device is operated by menus. The different parameters are displayed mainly in clear and can be displayed in various languages.

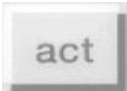
There are several windows for different functions and adjustments.

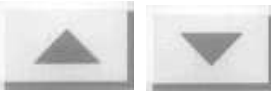
These windows can be selected by the following keys.

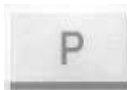
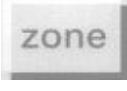
Key functions:

	Switching to the window: " Actual Process Values"
	Switching to the window: "Tendency Display"
	Changing of values. Changed values will not be valid until confirmed by pressing "E".
	Key "Enter" Power fail-safe saving of preselected values After parameter adjustment: Press "E" for approx 3s to return to Window "Actual Process Values"
	Key for choosing a parameter in the selected zone
	Switching to the window: "Zone Information" Switching to the next zone in different windows
	Selecting the window "Recorder Function" in the window "Zone Information"

Contrast setting:

Keep pressing key "E" and apply "UP" (lighter) or "DOWN" (darker) at the same time.

6.1 Window: Actual Process Values (key: "act")

Display of all actual process values of the connected zones

	<p>Examples of the possible displays:</p> <p>Zone 1: Actual process value 200 °C</p> <p>Zone 5: Switched off</p> <p>Zone 6: Sensor error, lower than measuring range</p> <p>Zone 7: Sensor error, higher than measuring range</p>
	<p>4-zone controllers display actual process values (large numbers) and setpoints (small numbers) simultaneously.</p>

6.2 Window: Tendency Display (key "trend")

Display of temperature tendency and alarms

The display allows a quick overview of the temperature relations in all zones.

	<p>Examples of display:</p> <p>Zone 1: Actual process value deviating from setpoint > 1 % of the measuring range upwards</p> <p>Zone 2: Process in balance. Deviation < 1 % from the measuring range</p> <p>Zone 5: Switched off</p> <p>Zone 6: Actual process value deviating from setpoint >3 % of the measuring range downwards</p> <p>Zone 7: Actual process value deviating from setpoint > 3 % of the measuring range upwards</p> <p>Alarm A1 of zone 7 is active. Alarm A2 of zone 6 is active.</p>
<p>If the option "heater current monitoring" has been activated and continuous current flow (short circuit of the semiconductor switches) is detected, "Permanent current" in the lower area is displayed.</p>	

6.3 Window: Zone Information (key "zone")

Display of process value, setpoint, output ratio, current, and status bar for the selected zone

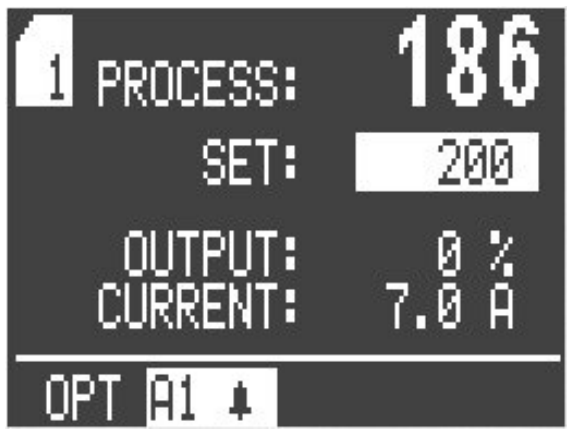
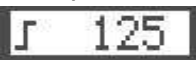
	<p>Adjusting the setpoint by arrow keys</p> <p>In case of a modified, but not yet confirmed value an "E" is blinking behind the setpoint: Confirm the selected value by pressing "E".</p> <p>OUTPUT: Display of output ratio Negative values: Cooling mode Asterisk: The output is active.</p> <p>CURRENT: Display of heater current (if active)</p> <p>Status display: e.g. autotune active, Alarm A1</p>	
Setpoint Line:	SET :	Setpoint 1 active If the ramp is active press the key „E“ to display the actual ramp setpoint: 
	SET SP2 :	Setpoint 2 active. Setpoint 2 is adjustable in the menu "Controller Parameters".
	MANUAL :	Manual output ratio active (manual mode)
Status Display:	OPT	Autotune active
	RAMP	Ramp active
	A1 ; A2	Alarm 1 or Alarm 2 is active.
	E . xx	Error messages

6.4 Window: Recorder Function

Display of temperature gradation over time for the selected zone

Select recorder function by pressing "fct" in the window "Zone Information".

Leaving the recorder function: Press key "fct" again.

This function enables the user to observe the transient response and the timing behaviour of the controller for the selected zone and to set parameters accordingly.

In the event of fault, the course taken by the actual value prior to the occurrence can be retrospectively examined.

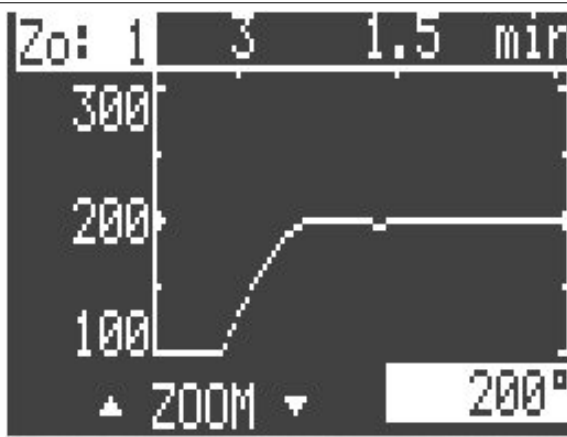
	<p>The time axis is defined by the "Sample Time"</p> <p>The actual value is always displayed symmetrically relating to the current setpoint. (here 200°)</p> <p>At the bottom right the actual process value is shown.</p> <p>By the arrow keys the resolution of the temperature axis may be changed (ZOOM).</p> <p>By pressing the key "zone" the individual zone may be selected.</p>
---	--

7 Parameter Descriptions

7.1 Configuration Parameters, Valid for the Complete Device

Select window "Actual Process Values" by pressing "act". Then press "P" and "E" simultaneously for approx 3s. The first Configuration Parameter will be shown. Adjust the values by using the arrow keys. Save the value by pressing "E". Select the next parameter with key "P".

Language (language)	Adjusting the language for the operator guidance Deutsch (German) <§> English (English)
Sensor mix PT100 (RTD) / TC	Selecting the kind of sensor for each zone. The zones can be configured in pairs of PT100 or thermocouple (TC): Example: Zo 1-8: TC All zones thermocouple Zo 1-2:PT100 Zo 3-8:TC Zo 1-4:PT100 Zo 5-8:TC <§> Zo 1-6:PT100 Zo 7-8:TC Zo 1-8:PT100 All zones PT100 For selecting the sensor type see chapter " Zone Configuration".

Alarm configurations, general information:

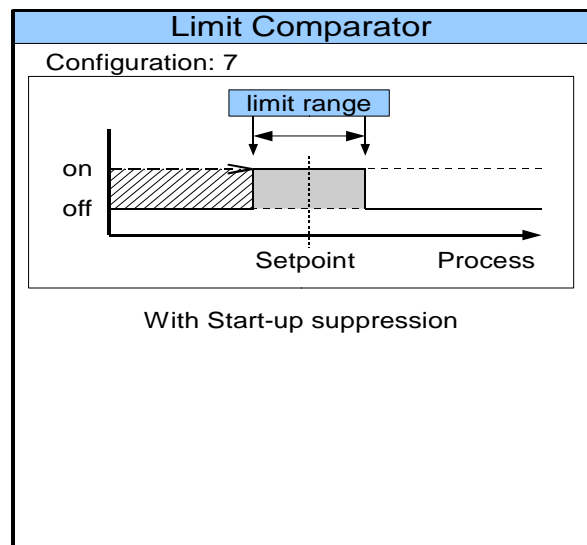
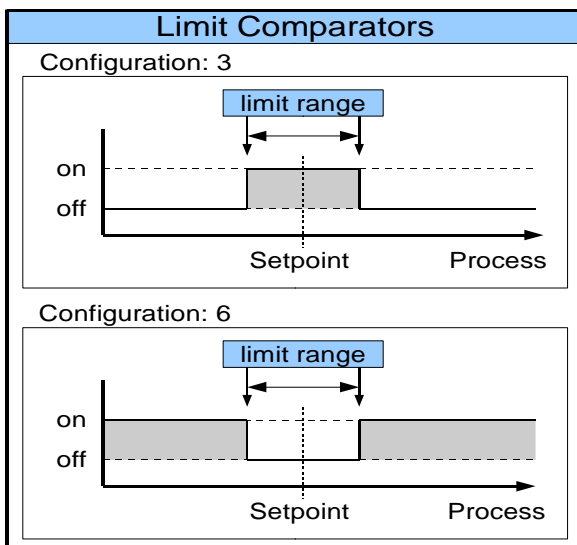
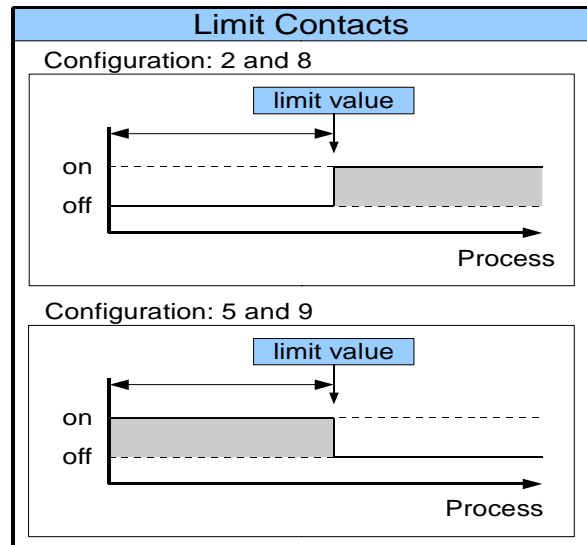
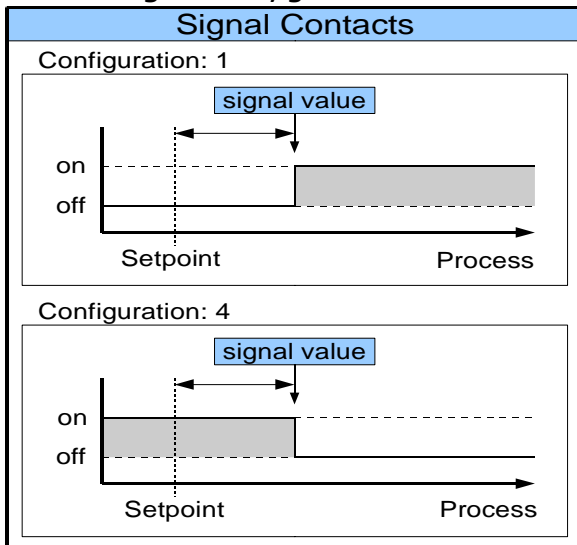

The controller features two independent alarms with one corresponding alarm relay each.

Each alarm contact works as a common alarm for all zones. The individual alarms A1 (A2) of all zones are connected to the common contact A1 (A2). The selected configuration is valid for all active zones.

Please note:

Care should be taken to ensure that the setpoints of the alarm contacts are programmed within the selected measuring range. If a setpoint ramp has been programmed, the alarms that are relative to the setpoint (signal contact, limit comparator) follow the setpoint ramp.

In case of sensor error the alarms react in the same way as range override.

The alarm contacts therefore do not offer protection against all types of plant breakdown.

We recommend the use of a second, independent monitoring unit.

The different alarm configurations define the working mode of the alarm. If the controller features a heater current monitoring, two additional heater current alarms are available. The actual alarm values have to be set in the menu "Control Parameters".

Alarm A1: Configuration Contact A1	Alarm off	co:0	<§>	
	Signal contact _ A ^	setpoint depend	co:1	
	Limit contact _ A ^	process depend	co:2	
	Limitcomparator _ A ^ _	setpoint depend	co:3	
	Signal contact ^ A _	setpoint depend	co:4	
	Limit contact ^ A _	process depend	co:5	
	Limitcomparator ^ A _ ^ A ^	setpoint depend	co:6	
	Limitcomparator _ A ^ _	ssup setpoint depend	co:7	Limit comparator with start-up <u>suppression</u>
	Heater current monitoring _ A ^	co:8		Heater current limit contact
	Heater current monitoring ^ A _	co:9		Heater current limit contact

Alarm A1: Relay switching behaviour	Here the relay function may be inverted: Direct: Alarm(A)=on ->Relay closed Inverse: Alarm(A)=off ->Relay closed	The relay is switched on if the controller displays an alarm message. <§> The relay is switched off if the controller displays an alarm message.
Alarm A2: Configuration Contact A1	Identical adjustment as Alarm A1: Configuration	
Alarm A2: Relay switching behaviour	Identical adjustment as Alarm A1: Relay switching behaviour	

Heater current monitoring (option)

The heater current monitoring function is valid for all connected zones.
The following parameters are displayed when the alarm configuration is programmed to "heater current" (8 or 9).

The alarm value (heater current value) is programmed as an absolute value.

Please note:

Ensure that the limit value is set correctly to avoid false alarms in case supply voltage changes.
The alarm can be delayed by selecting a "Delay time".

The heater current measuring is designed for a current transformer 1:1000.
(ELOTECH type: M2000)

Heater current detection and indication range:

0...max. 60,0 A Single-phase operation

0...max. 99,9 A Three-phase operation

The sum of all three phases currents is monitored.

Current detection cycle time (sec.)	1...60s <§ = 2s> Time interval between the current measurement of two successive zones
Alarm A1: Delay time (sec.)	5 steps adjustable, unit: seconds The values depend on the current detection cycle time and the number of active controller zones. off = no delay time active <§>
Alarm A2: Delay time (sec.)	5 steps adjustable, unit: seconds The values depend on the current detection cycle time and the number of active controller zones. off = no delay time active <§>

<p>Leakage current Min. limit value</p> <p>Monitoring concerning an impermissible permanent current</p>	<p>Value: off <§>, 0,0...99,9 A</p> <p>The sum of the actual leakage current will be displayed as "Act leak-curr."</p> <p>SSRs (especially if they are combined with RC-combinations) normally have small leakage currents.</p> <p>A leakage current limit value is programmable. All values below this limit will not be considered in the alarm monitoring.</p> <p>If a permanent current is detected the alarm will be activated. The status is displayed in the window "Tendency Display": "Permanent current"</p> <p>The zone with a permanent current can be detected by observing the actual process values (high values).</p>
<p>Current transformer: Turns ratio</p>	<p>1:100 ... 1:9999 < § = 1:1000 for M2000 ></p>

<p>Adjustment lock</p>	<p>All parameters adjustable</p> <p>Only setpoint 1 adjustable</p> <p>Setpoints, alarm-values and ramps adjustable</p> <p>All parameters locked</p>	<p>All parameters adjustable <§></p> <p>All other parameters are locked.</p> <p>Setpoints, alarm values and ramps are adjustable. All other parameters are locked.</p> <p>No parameter is adjustable.</p>
<p>The parameters that have been locked can be displayed but not changed. This adjustment cannot be changed if the external contact K2 is closed.</p>		
<p>Zones offset</p>	<p>off <§>, 1...91</p> <p>The adjusted offset value is added to the displayed zone numbers in the windows. Therefore a continuous numbering of the zones can be achieved if more than one device is used.</p> <p>Examples: offset = off: zones numbering: 1-4, 1-6, 1-8 offset = 4: zones numbering: 5-8, 5-10, 5-12</p>	

Serial Interface (RS232, RS485 or TTY)

The controllers of the series **R2400** can be equipped with a serial interface **RS232, RS485** or **TTY/20mA** (half-duplex) as an option.

This enables a master (PLC) to set and to read the process- and configuration parameters. The communication is always controlled by the master. The controller operates as a slave. If there are transmission or range errors detected by the slave, the message is not accepted and the existing parameter values remain valid.

In the parameter "**Serial Interface: Baud rate**" the activity of the data communication is displayed. After a successful communication the word "Data" is shown for a short time.

It is not possible to operate the device by keyboard if it is set to remote-operation by the master.

Protocol descriptions and further information: Please see www.elotech.de/downloads

Serial Interface: Protocol selection	Standard ELOTECH Modbus	Standard ELOTECH protocol <\$> Modbus- RTU protocol
Serial Interface: Device address	1<\$>... 255 At this address a master communicates with the controller. Each controller needs a unique address.	
Serial Interface: Data format	Adjusting the data format for the transmission: Data bit: 7 Parity: even Stop bit: 1 Data bit: 7 Parity: odd Stop bit: 1 Data bit: 7 Parity: even Stop bit: 2 Data bit: 7 Parity: odd Stop bit: 2 Data bit: 7 Parity: no Stop bit: 2 Data bit: 8 Parity: even Stop bit: 1 Data bit: 8 Parity: odd Stop bit: 1 Data bit: 8 Parity: no Stop bit: 1 Data bit: 8 Parity: no Stop bit: 2	
Serial Interface: Baud rate	off 300 baud 600 baud 1.2 kbaud 2.4 kbaud 4.8 kbaud 9.6 kbaud <\$> 19.2 kbaud 38.4 kBaud	Interface inactive

Profibus Interface

The following parameters are visible if the device is equipped with a Profibus-DP-interface (option).

This enables a master (PLC) to set and to read the process- and configuration parameters. The communication is always controlled by the master. The controller operates as a slave. If there are transmission or range errors detected by the slave, the message is not accepted and the existing parameter values remain valid.

In the parameter "**PROFIBUS DP:Baud rate**" the status of the interface is displayed.

no connection	Profibus not connected or master inactive
wait param.	Master detected – device expects initialization
data exchange	Data Exchange Mode

By Profibus all process values and configuration parameters can be read at any time. If the master wants to write parameters to the controller, the parameter "**PROFIBUS DP:Remote**" has to be set to "on".

Protocol descriptions and further information: Please see www.elotech.de/downloads

PROFIBUS DP: Remote	off Profibus read-only; Keyboard-operation on Profibus read/write; No keyboard operat.	Keyboard operation permitted, Profibus can read only. <\$> Keyboard operation locked (display REMO), Profibus can read and write.
PROFIBUS DP: Device address	1<\$>...125 At this address a master communicates with the controller. Each controller needs a unique address.	
PROFIBUS DP: Baud rate	The baud rate will be detected and only displayed automatically. It is not adjustable. Supported baud rates: 12 Mbaud 6 Mbaud 3 Mbaud 1.5 Mbaud 500 kbaud 187.5 kbaud 93.75 kbaud 45.45 kbaud not detected No valid baud rate detected.	

CANopen Interface

The following parameters are visible if the device is equipped with a CANopen interface. (option)

This enables a master (PLC) to set and to read the process- and configuration parameters.

In the parameter "**CANopen: Baud rate**" the activity of the data communication is displayed. After a successful communication the word "Data" is shown for a short time.

The control operation will start when the controller is set into "operational mode" by the CANopen-master. In this case the keyboard is locked.

For control operation without CAN-interface close contact K4.

Note: A CAN-network has to be terminated on both ends with terminating resistors (120 Ohm).

CANopen-specification	CANopen Master:	no
	CANopen Slave:	yes
	Extended Boot-up:	no
	Minimum Boot-up:	yes
	COB ID Distribution:	yes; default via SDO
	Node ID Distribution:	no; via device keyboard
	No. of PODs:	0RX, 1TX
	PDO Modes:	async.
	Variable PDO mapping:	no
	Emergency message:	yes
	Life guarding:	yes
	No. of SDO`s:	1RX, 1TX
	Device Profile:	CiA DS-404

Protocol descriptions and further information: www.elotech.de/Downloads

CANopen Device address	1<§> . . . 127 At this address a master communicates with the controller. Each controller needs a unique address.
CANopen Baudrate	20 kbaud <§> 50 kbaud 100 kbaud 125 kbaud 250 kbaud 500 kbaud 1000 kbaud

SERVICE Interface:	1...255
Device address	See chapter „Service interface“
Recorder function:	Time difference between two successive process value samples.
Sample time	<p>In brackets: the total time period which can be monitored</p> <p>2,5 sec.(Total time: 3,7min) 5 sec.(Total time: 7,5min) 10 sec.(Total time: 15min) <§> 30 sec.(Total time: 45min) 1 min.(Total time: 1,5h) 5 min.(Total time: 7,5h) 10 min.(Total time: 15h)</p> <p>Up to 90 temperature values can be stored.</p>
Device code:	24.xx Device type and number of channels E1.02x Firmwareversion

End of the Configuration Parameters list

7.2 Zone Configuration

Select window **"Zone Information"** by pressing **"zone"**. Then press **"P"** and **"E"** simultaneously for approx 3s. The first Zone Configuration Parameter will be shown. Adjust the values by using the arrow keys. Save the value by pressing **"E"**. Select the next parameter with key **"P"**.

Zone on/off	on Measuring- or controller zone active <§> off Measuring- or controller zone switched off	
Controller configuration	2 point controller heating-off	2-point controller "heating-off" <§>
	2 point controller cooling-off	2-point controller "cooling-off"
	2 point controller cooling non linear	2-point controller "cooling non linear". Cooling action with non-linear cooling response curve (e.g. for vapour cooling).
	3 point controller heating-cooling	3-point-controller "heating-off-cooling" >3<
	3 point controller heating-cool n. lin	3-point-controller "heating-off-cooling". Cooling action with non-linear cooling response curve (e.g. for vapour cooling). >3<
	Indicator no controller action	Indicator, no controller action

Sensor selection	<p>If the zone is configured to PT100, the following sensors are available:</p> <table border="0"> <tr><td>PT100 (RTD)</td><td>-50,0...100,0°C</td></tr> <tr><td>PT100 (RTD)</td><td>-58...212°F</td></tr> <tr><td>PT100 (RTD)</td><td>-90,0...205,0°C</td></tr> <tr><td>PT100 (RTD)</td><td>-130...401°F</td></tr> <tr><td>PT100 (RTD)</td><td>0...400°C <§></td></tr> <tr><td>PT100 (RTD)</td><td>32...752°F</td></tr> <tr><td>PT100 (RTD)</td><td>0...800°C</td></tr> <tr><td>PT100 (RTD)</td><td>32...1472°F</td></tr> <tr><td>Ni120</td><td>0...250°C</td></tr> <tr><td>Ni120</td><td>32...482°F</td></tr> </table> <p>If the zone is configured to thermocouple, the following sensors are available:</p> <table border="0"> <tr><td>TC Type L, Fe-CuNi</td><td>0...400°C</td></tr> <tr><td>TC Type L, Fe-CuNi</td><td>32..752°F</td></tr> <tr><td>TC Type L, Fe-CuNi</td><td>0...800°C</td></tr> <tr><td>TC Type L, Fe-CuNi</td><td>32..1472°F</td></tr> <tr><td>TC Type J, Fe-CuNi</td><td>0...800°C</td></tr> <tr><td>TC Type J, Fe-CuNi</td><td>32..1472°F</td></tr> <tr><td>TC Type K, NiCr-Ni</td><td>0..1200°C</td></tr> <tr><td>TC Type K, NiCr-Ni</td><td>32..2192°F</td></tr> <tr><td>TC Type S, PtRh-Pt</td><td>0..1600°C</td></tr> <tr><td>TC Type S, PtRh-Pt</td><td>32..2912°F</td></tr> <tr><td>TC Type N, NiCrSi-NiSi</td><td>0..1200°C</td></tr> <tr><td>TC Type N, NiCrSi-NiSi</td><td>32..2192°F</td></tr> </table> <p>Please note: If the sensor selection is changed, the following parameters will be reset:</p> <table border="0"> <tr><td>Setpoint 1, Setpoint 2:</td><td>Setpoint limitation min.</td></tr> <tr><td>Lower setpoint limitation:</td><td>measuring range bottom</td></tr> <tr><td>Higher setpoint limitation:</td><td>measuring range top</td></tr> <tr><td>Setpoint ramp rising/falling:</td><td>off</td></tr> <tr><td>Alarm values:</td><td>off</td></tr> <tr><td>Actual process value offset:</td><td>off</td></tr> </table>	PT100 (RTD)	-50,0...100,0°C	PT100 (RTD)	-58...212°F	PT100 (RTD)	-90,0...205,0°C	PT100 (RTD)	-130...401°F	PT100 (RTD)	0...400°C <§>	PT100 (RTD)	32...752°F	PT100 (RTD)	0...800°C	PT100 (RTD)	32...1472°F	Ni120	0...250°C	Ni120	32...482°F	TC Type L, Fe-CuNi	0...400°C	TC Type L, Fe-CuNi	32..752°F	TC Type L, Fe-CuNi	0...800°C	TC Type L, Fe-CuNi	32..1472°F	TC Type J, Fe-CuNi	0...800°C	TC Type J, Fe-CuNi	32..1472°F	TC Type K, NiCr-Ni	0..1200°C	TC Type K, NiCr-Ni	32..2192°F	TC Type S, PtRh-Pt	0..1600°C	TC Type S, PtRh-Pt	32..2912°F	TC Type N, NiCrSi-NiSi	0..1200°C	TC Type N, NiCrSi-NiSi	32..2192°F	Setpoint 1, Setpoint 2:	Setpoint limitation min.	Lower setpoint limitation:	measuring range bottom	Higher setpoint limitation:	measuring range top	Setpoint ramp rising/falling:	off	Alarm values:	off	Actual process value offset:	off
PT100 (RTD)	-50,0...100,0°C																																																								
PT100 (RTD)	-58...212°F																																																								
PT100 (RTD)	-90,0...205,0°C																																																								
PT100 (RTD)	-130...401°F																																																								
PT100 (RTD)	0...400°C <§>																																																								
PT100 (RTD)	32...752°F																																																								
PT100 (RTD)	0...800°C																																																								
PT100 (RTD)	32...1472°F																																																								
Ni120	0...250°C																																																								
Ni120	32...482°F																																																								
TC Type L, Fe-CuNi	0...400°C																																																								
TC Type L, Fe-CuNi	32..752°F																																																								
TC Type L, Fe-CuNi	0...800°C																																																								
TC Type L, Fe-CuNi	32..1472°F																																																								
TC Type J, Fe-CuNi	0...800°C																																																								
TC Type J, Fe-CuNi	32..1472°F																																																								
TC Type K, NiCr-Ni	0..1200°C																																																								
TC Type K, NiCr-Ni	32..2192°F																																																								
TC Type S, PtRh-Pt	0..1600°C																																																								
TC Type S, PtRh-Pt	32..2912°F																																																								
TC Type N, NiCrSi-NiSi	0..1200°C																																																								
TC Type N, NiCrSi-NiSi	32..2192°F																																																								
Setpoint 1, Setpoint 2:	Setpoint limitation min.																																																								
Lower setpoint limitation:	measuring range bottom																																																								
Higher setpoint limitation:	measuring range top																																																								
Setpoint ramp rising/falling:	off																																																								
Alarm values:	off																																																								
Actual process value offset:	off																																																								
Process offset	<p>- 999..off<§>..1000 for measuring range without decimal point - 9,9..off<§>..10,0 for measuring range with decimal point</p> <p>This parameter serves to correct the input signal, e.g. for:</p> <ul style="list-style-type: none"> - the correction of a gradient between the measuring point and the sensor tip - the line resistance balancing of 2-line RTD (Pt100) sensors - correction of the control deviation when using P- or PD-action <p>If for example the offset value is set to +5°C, the real temperature measured by the sensor (when process is balanced) is 5 °C less than the setpoint and the displayed actual process value.</p> <p>Make sure that the corrected temperature process value does not leave the selected measuring range.</p>																																																								
Setpoint limitation: max. setpoint	<p>Highest adjustable setpoint value <§= 400°C> programming range: Setpoint limitation: min.setpoint ... top range</p>																																																								
Setpoint limitation: min. setpoint	<p>Lowest adjustable setpoint value <§ = 0°C> programming range: bottom range ... Setpoint limitation: max. setp.</p>																																																								

Softstart Function in General:

If you select the softstart function, make sure that the instrument is equipped with bistable voltage (logic) outputs. This function is not allowed for instruments with relay outputs. Otherwise the relays will be damaged.

During the softstart the controller's heating output response is limited to a preselected ratio, in order to achieve a slow drying of high performance heat cartridges. This results in a slower, more regular heating period. Simultaneously the output clock frequency is quadrupled.

Once the process value reaches the softstart setpoint, it remains stable at this value for the preselected duration time.

At the end of this period the process value rises to the valid setpoint.

If the softstart is active, the controller's autotune function cannot operate (E.OP). If a setpoint ramp has been programmed, the softstart has priority, and the ramp will become active after the softstart has been completed.

The softstart only works

- if the parameter P (xp) is programmed $\geq 0,1\%$
- if the actual process value is lower than the softstart setpoint – 5% of the selected measuring range

It is possible to select this function for each zone individually.

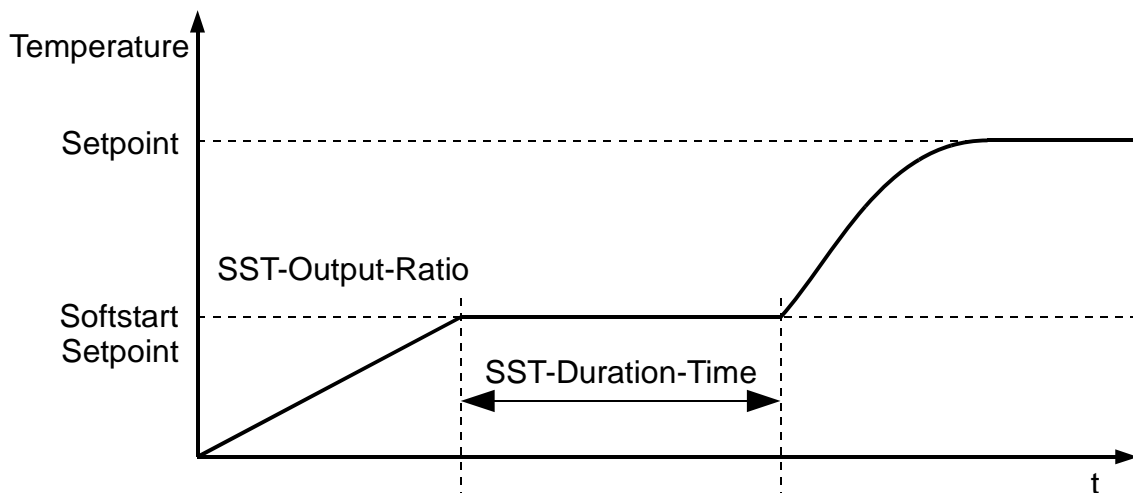

Softstart: on/off	off Softstart function is not active.<§> The other softstart parameters are not displayed. on Softstart function is active.
Softstart: output ratio (%)	range: 10...100% <§ = 30>
Softstart: setpoint	range: setpoint min. setpoint max. <§ = 100>
Softstart: duration time (min.)	range: off, 0.1 ... 10.0 min <§ = 2.0>

Output mode	Controller mode	Controller mode
	Actuator mode AUTOMATIC	<p>In the event of sensor break the last valid output ratio is maintained.</p> <p>Select window: Zone Information PROCESS: Error warning: Er.H or Er.L. MANUAL: The actual output ratio is shown.</p> <p>SETPOINT: First an "H", then the actual adjustable output ratio. Particularity in display: H99 = 100 %</p> <p>Like the setpoint, the output ratio can be changed manually.</p> <p>Under the following circumstances, the output ratio will be 0%:</p> <ul style="list-style-type: none"> - if the output ratio at the time of the sensor break was 100%. - if a setpoint ramp is active. - if the control deviation was more than 0,25% of the total range at the time of sensor break. - if the Proportional-band (P) = off. - if the softstart was active at the time of the sensor break. <p>A few seconds after the sensor break has been rectified, the controller returns to automatic operation and calculates the required output ratio.</p> <p>An additional signal can be issued in the event of sensor break, if the alarm contacts are programmed accordingly.</p>
Copy all parameters of this zone to destination zone:	Actuator mode MANUAL	<p>The controller now operates only as an actuator. The control function (PID) is inactive.</p> <p>PROCESS: Actual process value is shown. Display of setpoint: First an "H", then the actual adjustable output ratio. Particularity in display: H99 = 100 %</p> <p>Like the setpoint, the output ratio can be changed manually.</p>
<p>The parameter set of this zone can be copied to other zones. Please note: This will only happen if the selected sensor types in the source and in the destination zone are identical.</p> <p>Set the zone number of the destination zone and confirm by "enter".</p> <p>If "All" is selected as destination zone, the parameters will be copied to all zones.</p> <p>The copy function may take several seconds.</p>		

7.3 Control Parameters, Zone Dependent

Select window **"Zone Information"** by pressing **"zone"**. Select the parameters by pressing **"P"**. Adjust the values by using the arrow keys. Save the value by pressing **"E"**. Select the next parameter with key **"P"**.

Setpoint 2	Off<§>; Setpoint limitation: min. setpoint ... Setpoint limitation: max. setpoint If the external contact K1 is closed, the setpoint 2 becomes active in all zones in which Setpoint 2 is not set to "off".
-------------------	--

Ramp function:

A programmed ramp is always activated when the setpoint is changed or when the mains supply is switched on. The ramp starts at the actual process value and ends at the preselected setpoint. The ramp can be activated for both setpoint 1 and setpoint 2. By programming the second setpoint accordingly a setpoint profile can be obtained. (Please see example below.)

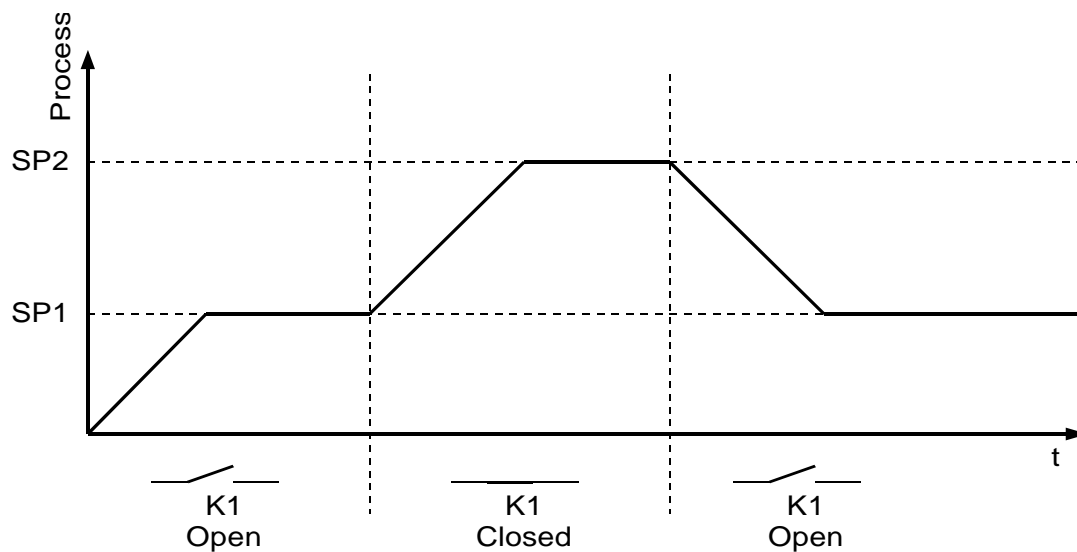

Rising ramp	off<§>, 0,1 ... 99,9	°C/min or °F/min for measuring range without decimal point
	off<§>, 0,01 ... 9,99	°C/min or °F/min for measuring range with decimal point
Falling ramp	off<§>, 0,1 ... 99,9	°C/min or °F/min for measuring range without decimal point
	off<§>, 0,01 ... 9,99	°C/min or °F/min for measuring range with decimal point

Alarm A1: Alarm value switches relay A1	Before adjusting an alarm value, the alarm configuration has to be set.	
	Temperature monitoring:	Adjustment range
	Signal contact, without decimal point	off<§>, -199...199
	Signal contact, with decimal point	off<§>, -19,9...19,9
	Limit comparator, without decimal point	off<§>, 1... 199
	Limit comparator, with decimal point	off<§>, 0,1... 19,9
	Limit contact, adjustment according to measuring range	off<§>, Measuring range, bottom end ... top end
Alarm A2: Alarm value switches relay A2	Identical setting as Alarm A1:Alarm value	
Max. output ratio limitation(%)	0%...100%<§> The limitation of the output ratio is only necessary if the heating energy supply is grossly overdimensioned compared to the power required. Under normal conditions a limitation is not necessary (setting = 100%). The limitation becomes effective when the controller's calculated output ratio is greater than the maximum permissible (limited) ratio. Warning! The output ratio limitation does not work during autotune.	

Adjustment of the control parameters:

As standard the controller operates in PD/I control mode, i. e. controlling without deviation and with practically no overshoot during start-up.

3-point controllers (marked with: >3<) have a second "cooling" parameter set.

The control action can be altered in its structure by adjusting the following values to the parameters:

- | | |
|------------------------------|----------------------------------|
| a. no control action, on-off | setting P = off |
| b. P-action | setting D and I = off |
| c. PD-action | setting I = off |
| d. PI- | setting D = off |
| e. PD/I | modified PID-mode (set: P, D, I) |

According to the configuration, certain parameters are not visible.

P (xp) Proportional band (%)	off, 0.1 ... 100.0% <§=3,0>
D (Tv) Rate time (sec.)	off, 1 ... 200s <§=30>
I (Tn) Reset time (sec.)	off, 1 ... 1000s <§=150>

<p>Cycle time (sec.)</p>	<p>0,5...240,0 s <§=10,0></p> <p>The switching frequency of the actuator can be determined by adjusting the cycle time. In this time interval the controller switches on and off once.</p> <p><u>Voltage outputs for SSRs</u> cycle time: 0,5...10 s Optimal value for fast control loops: 0,8s</p> <p><u>Relay outputs:</u> cycle time: > 10 s The cycle time should be adjusted to a time as long as possible to minimize the wear of the relay contacts.</p>
<p>Switch sensitivity</p>	<p>Only if „P- Band“ = off (on-off action, without feedback) off; 0,1<§>..80,0 °C/°F for range without decimal point off; 0,01<§>..8,00 °C/°F for range with decimal point</p> <div data-bbox="632 595 1222 958" data-label="Figure"> </div>
<p>Deadband heat <-> cool</p> <p style="text-align: right;">>3<</p>	<p>off; 0,1<§>..80,0 for range without decimal point off; 0,01<§>...8,00 for range with decimal point</p> <p>If the controller is in heating mode, the actual process value has to rise by the adjusted value above the setpoint before the cooling mode will become active. By this the switching frequency between the heating and cooling outputs can be reduced. Simultaneous activation of heating and cooling outputs is not possible.</p>
<p>Max. output ratio limitation cooling (%)</p> <p style="text-align: right;">>3<</p>	<p>0%...100%<§></p> <p>The limitation of the output ratio is only necessary if the heating or cooling energy supply is grossly overdimensioned compared to the power required. Under normal circumstances no limitation is needed (setting = 100%). The limitation becomes effective when the controller's calculated output ratio is greater than the maximum permissible (limited) ratio. Warning! The output ratio limitation does not work during autotune.</p>
<p>P (xp) Proportional band cooling (%)</p> <p style="text-align: right;">>3<</p>	<p>off, 0.1 ... 100.0% <§=3.0></p>
<p>D (Tv) Rate time cooling (sec.)</p> <p style="text-align: right;">>3<</p>	<p>off, 1 ... 200s <§=30></p>
<p>I (Tn) Reset time cooling (sec.)</p> <p style="text-align: right;">>3<</p>	<p>off, 1 ... 1000s <§=150></p>

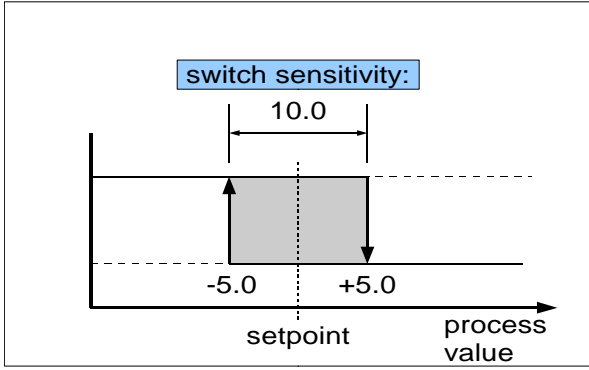
<p>Cycle time cooling (sec.)</p> <p>>3<</p>	<p>0,5...240,0 s <§=10,0></p> <p>The switching frequency of the actuator can be determined by adjusting the cycle time. This is the total time needed for the controller to switch on and off once.</p> <p>Bistable voltage outputs: cycle time 0,5...10 secs / optim. = 0,8secs.</p> <p>Relay outputs: cycle time > 10 secs The cycle time should be set as long as possible to minimize the wear of relay contacts.</p>
<p>Switch sensitivity cooling</p> <p>>3<</p>	<p>Only if „P- Band“ = off (on-off action, without feedback) off; 0,1<§>...80,0 for measuring range without dec. point off; 0,01<§>...8,00 for measuring range with decimal point</p>  <p>The diagram illustrates the switch sensitivity. It shows a horizontal axis labeled 'process value' with a vertical dashed line representing the 'setpoint'. A shaded rectangular band is centered on the setpoint, with a width of 10.0. The left edge of the band is at -5.0 and the right edge is at +5.0. A label 'switch sensitivity:' is positioned above the band.</p>

Autotune:

The tuning algorithm determines the characteristic values within the controlled process and calculates the valid feedback parameters (P,D,I) and the cycle time (= 0.3 x D) of a PD/I-controller for a wide section of the range.

The autotune mode is activated during start-up shortly before the setpoint is reached. If activated after the setpoint has already been reached, the temperature will first drop by approx. 5% of the measuring range in order to detect the exact amplification of the process.

Autotune active: Indication in display "Zone Information": OPT

The tuning algorithm can be activated at any time by selecting the parameter **Autotune = on**. After having calculated the feedback parameters, the controller will lead the process value to the actual setpoint.

Selecting **Autotune = off** will stop the autotune function.

Conditions for starting the Autotune algorithm:

- The setpoint must amount to at least 5% of the measuring range.
- The sensor must not have a failure.
- The softstart function must not be active.

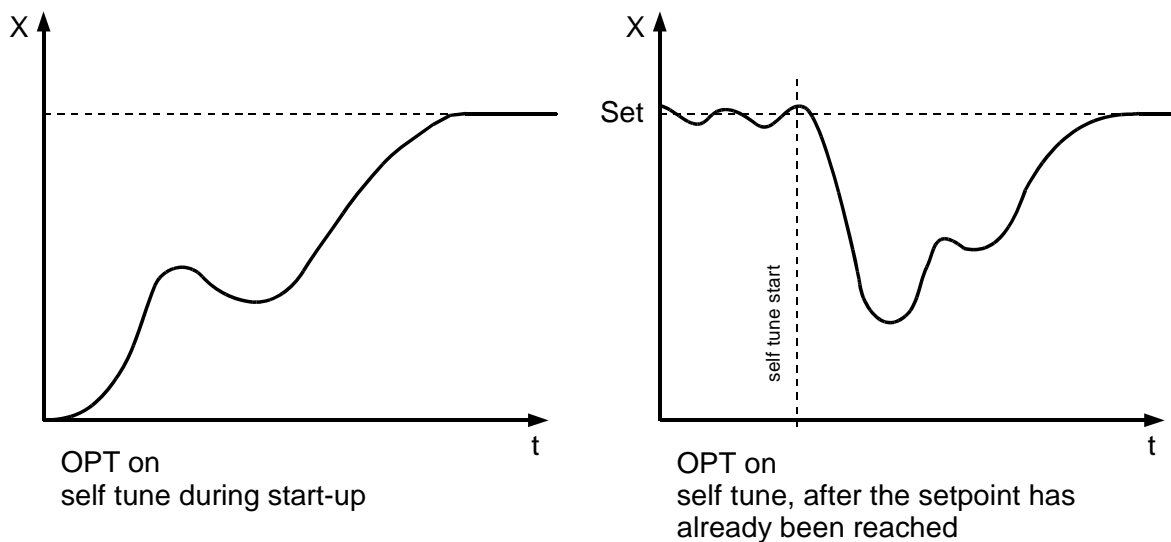

Autotune	off	autotune / self tuning out of action<§>
	on	autotune / self tuning is active
	all zones	<+Vers EL.02A> Autotune is started for all zones meeting the required conditions for the autotune algorithm. The function "all zones" is not supported by the fieldbus interfaces.

8 Service-Interface

The multi-zones-controllers **R2400S** are equipped with a serial service interface. It is designed to communicate with the software tool ELOVISION 2 which will allow the user to configure the controller by PC.

The following options are available:

- Read out all controller parameters.
- Modify all parameters.
- Save complete parameter sets on the PC (tool / setup management).
- Load back a setup from the PC to the controller. A once saved configuration can be copied to an unlimited number of controllers.
- Print a setup protocol.
- Visualization of all process values, setpoints and operating conditions

Interface parameters:

- Type: RS485, connection to terminal 95 (A) and 96 (B). A termination resistor (120 ohm) is required on both ends of the line!
- Baudrate: 115.2 kBaud (not adjustable)
- Format: 8 N 1 (not adjustable)
- Device address: Adjustable in the parameter "SERVICE interface: Device address"

When ordering the controller it has to be chosen whether the service interface is activated or not. If not ordered ex works there will be the note "not enabled" visible at the bottom of the screen. For later use of the service interface, it can be activated with the ELOVISION 2 software. Please contact the manufacturer for obtaining a licence key.

9 Error Messages

Error message	Cause	Possible remedy
LOC	Parameter has been locked.	Unlock, if need be Device parameter-> Adjustment lock
LOC EXT	Parameter has been locked by external contact K2.	Open contact K2
Er.H	Top range end has been exceeded, sensor defect	Check sensor and cable
Er.L	Bottom range end has been exceeded, sensor defect	Check sensor and cable Check process value offset
E.Op	Autotuning error	Quit error message by pressing the key "E". Check the autotuning conditions and restart. Autotune was cancelled after a time out of 2 hours.
E.Sy	System error	Quit error message by pressing the key "E". Check all parameters. If the error message continues, please send the controller back to the manufacturer.
Er.0	System error	Please send the controller back to the manufacturer.
REMO	Adjusting or programming of parameters by keyboard is not possible. Remote-status	Profibus: Set parameter "Remote" : off Serial Interface: The master has set the controller to "Remote". CAN: The controller is in operational mode.
KONF	Adjusting of alarm values not possible. Alarm configuration: "off"	Set parameter "Alarm Configuration" See: Device Configuration -> Alarm Configuration
E.SP2	Setpoint 2 active	Setpoint 2 cannot be adjusted in window "Zone Information". Adjustment is only possible in level "Control Parameters".

10 Technical Data

Input PT100 (RTD)	2- or 3- wire connection possible Built-in protection against sensor breakage and short circuit Sensor current: ... ≤ 1 mA Calibration accuracy: ... $\leq 0,2$ % Linear error: ... $\leq 0,2$ % Influence of the ambient temperature: ... $\leq 0,01$ % / K
Input Thermocouple	Built-in internal compensation point and protection against sensor breakage and incorrect polarity. Re-calibration not required for a line resistance of up to 50 Ohm. Calibration accuracy: ... $\leq 0,25$ % Linear error: ... $\leq 0,2$ % Influence of the ambient temperature: ... $\leq 0,01$ % / K
External contacts	Designed for connecting external potential-free contacts. The contact voltage (approx. 24 V DC, max. 1mA) is provided at controller terminal 75.
Heater current monitoring	Measuring input range: 0 ... 100mA corresponding 0,0 ... 99,9A when using a current transformer 1:1000. If the value of 100mA is exceeded, the controller may be damaged.
Control outputs	Bist. voltage signal, 0/18 V DC, max. 10 mA, short-circuit proof or Relay, max. 250 VAC, max. 3 A (resistive load)
Alarm outputs	Relay, max. 250 VAC, max. 3 A (resistive load)
LCD-Display	Blue STN-display with permanent, white LED-background lightening Graphic: 128 x 64 pixel Text: 8 lines with 21 characters each
Data protection	EAROM When using a Fieldbus interface please note: Permissible writing operations per parameter must not exceed 1 000 000.
CE-mark	Tested according to 2004/108/EG; EN 61326-1 Electrical safety: EN 61010-1
Power supply	Depends on the version of the device: - 230 V AC, +/-10 %, 48 ... 62 Hz; approx. 10VA - 115 V AC, +/-10 %, 48 ... 62 Hz; approx. 10VA - 24 V DC, +/-25 %, approx. 10W
Connections	Screw terminals, Protection mode IP 20 (DIN 40050), Insulation class C
Permissible operating conditions	Operating temperature: 0 ... 50°C / 32 ... 122°F -30 ... 70°C / -22 ... 158°F Storage temperature: KWF DIN 40040; equivalent to annual average Climate class: max. 75 % rel. humidity, no condensation
Casing	Format, case: ¼-DIN; 96 x 96 mm (DIN 43700), installation depth 122 mm Panel cutout: 92 +0,5 mm x 92 +0,5 mm Format, face plate: 98x98mm Material: Noryl, self-extinguishing, non-drip, UL 94-V1 Protection mode: IP 20 (DIN 40050), IP 50 front side
Weight	Approx. 800g, depends on the version of the device
Fieldbus Interface: (optically isolated)	Depends on the version of the device: - Serial: RS232, RS485, TTY (20mA) - CANopen, CiA Device Profile DS-404 - Profibus DP, according to EN 50170
Service Interface (Option):	RS485, 115,2 kBaud, 8N1

Subject to technical improvements.