

R2500 S with service interface

Multi-zone temperature controller

8 | 10 | 12 | 16 zone 2-point controller

8 zone 3-point controller



Installation depth: 122mm
Format, case: 194mm x 98mm

DESCRIPTION AND OPERATING MANUAL

ELOTECH Industrieelektronik GmbH
Verbindungsstrasse 27
D - 40723 HILDEN
FON +49 2103 / 255 97 0 FAX +49 2103 / 255 97 29
www.elotech.de Email: info@elotech.de

1 Contents

1	Contents.....	2
2	General Information.....	3
3	Installation Instructions.....	3
4	Type Code.....	4
5	Connection Diagram.....	5
5.1	Power Supply and Outputs.....	5
5.2	Sensor Inputs.....	7
5.3	Additional Functions.....	8
5.4	Fieldbus Interfaces.....	8
6	Display and Keyboard.....	9
6.1	Menu 1: Display Windows.....	10
6.2	Menu 2: Configuration Windows.....	12
7	Parameter Descriptions.....	14
7.1	Configuration Parameters, Valid for the Complete Device.....	14
7.2	Control Parameters, Zone Dependent.....	22
8	Service-Interface.....	30
9	Error Messages.....	30
10	Technical Data.....	31
11	Notes.....	32

2 General Information

Used symbols:

Alarm	Messages shown by the controller are written in this font.
<§>	Symbolizes the value of the factory adjustment of the respective parameters.
>3<	This parameter is available in 3-point controllers only.
<+Vers EL.02A>	For this feature firmware version EL.02A or later is required. The actual firmware version is displayed in the window "Device status"

3 Installation Instructions

Make certain that the device is used for the intended purpose only.

R2400 controllers are designed for installation in control panels.
Protect the device against impermissible humidity and contamination.

Ambient temperature may not exceed 50 °C (122 °F).
Electrical connections must be made according to valid regulations and by properly qualified personnel.

If using thermocouple sensors, compensation lines have to be connected directly to the controller terminals. Sensors may be connected only in compliance with the programmed range.

Sensor cables and signal lines (e.g. logic or linear voltage outputs) must be laid separately from control lines and mains voltage supply cables (power cables).
It is not permitted to connect the grounds of the sensor-inputs and Logic-outputs with each other.

Separate installation of controller and inductive loads is recommended.
Interference from contactor coils must be suppressed by connecting adapted RC-combinations parallel to the coils.
Control circuits (e.g. for contactors) should not be connected to the mains power supply terminals of the controller.

The configuration parameters are generally to be selected first.

Disclaimer of Liability

We have checked the contents of this document for conformity with the hardware and software described. Nevertheless, we are unable to preclude the possibility of deviations so that we are unable to assume warranty for full compliance. However, the information given in the publication is reviewed regularly. Necessary amendments are incorporated in the following editions.
We would be pleased to receive any improvement proposals which you may have.
The information contained herein is subject to change without notice.

Electronic scrap and components are subject to special treatment and must be disposed of by authorized companies.

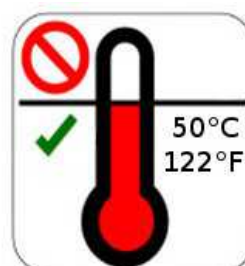

4 Type Code

R2500 - aaa - x - y - 000 - d - z

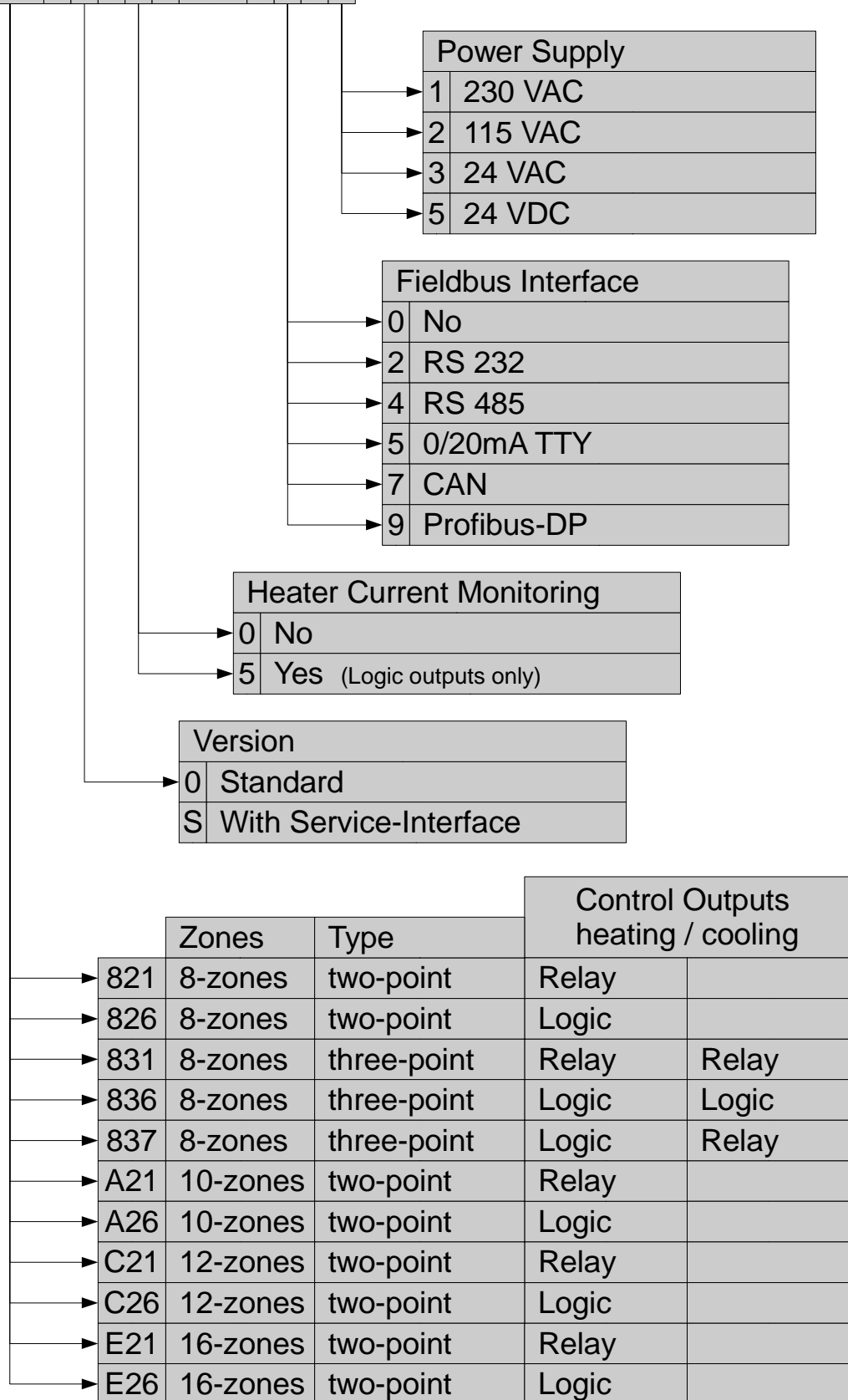

5 Connection Diagram

5.1 Power Supply and Outputs

Type: 821, A21, C21, E21

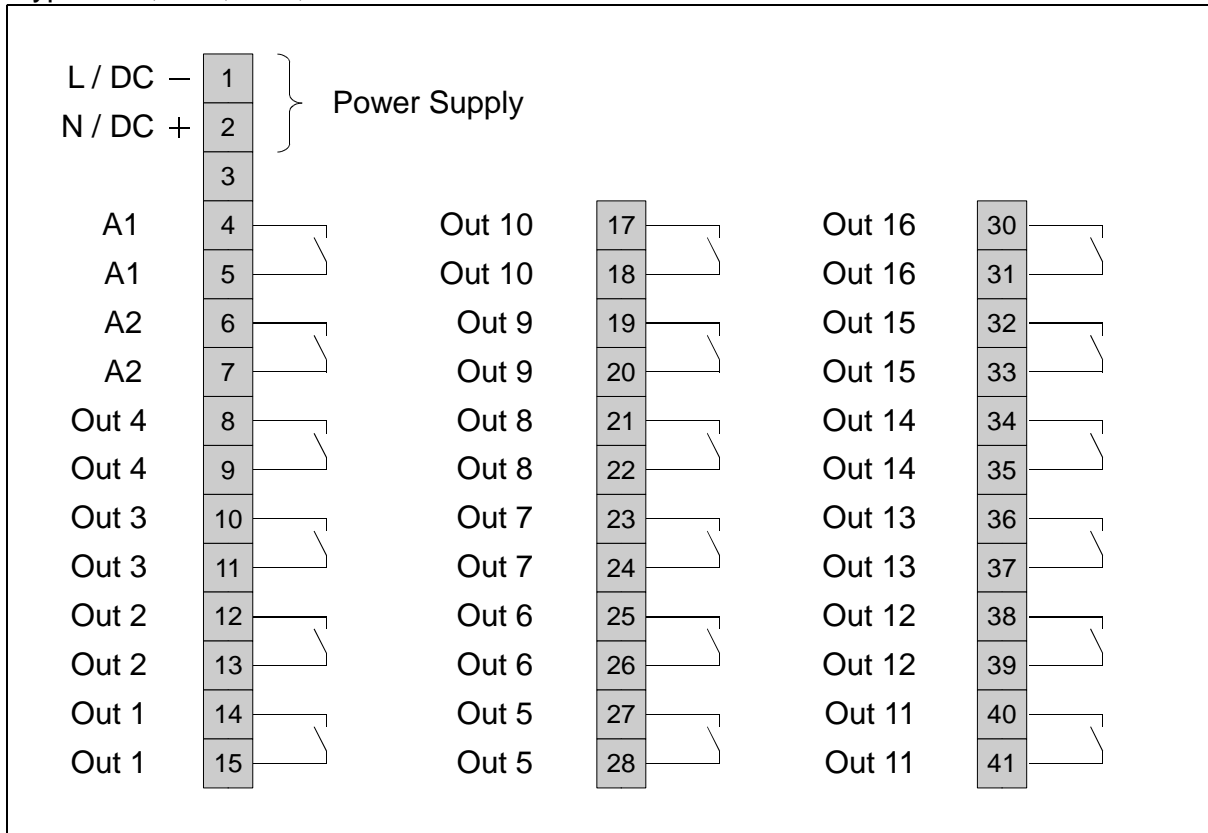

Type: 826, A26, C26, E26

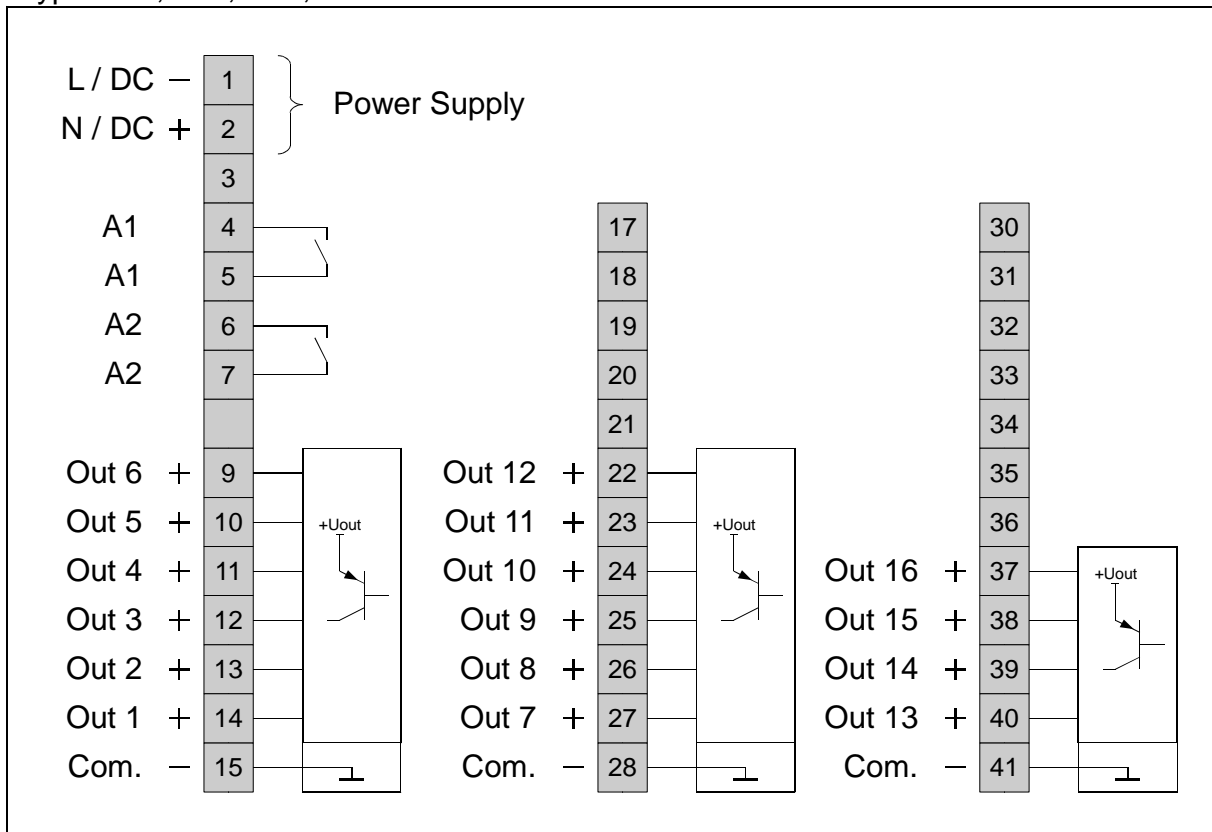

Type: 836

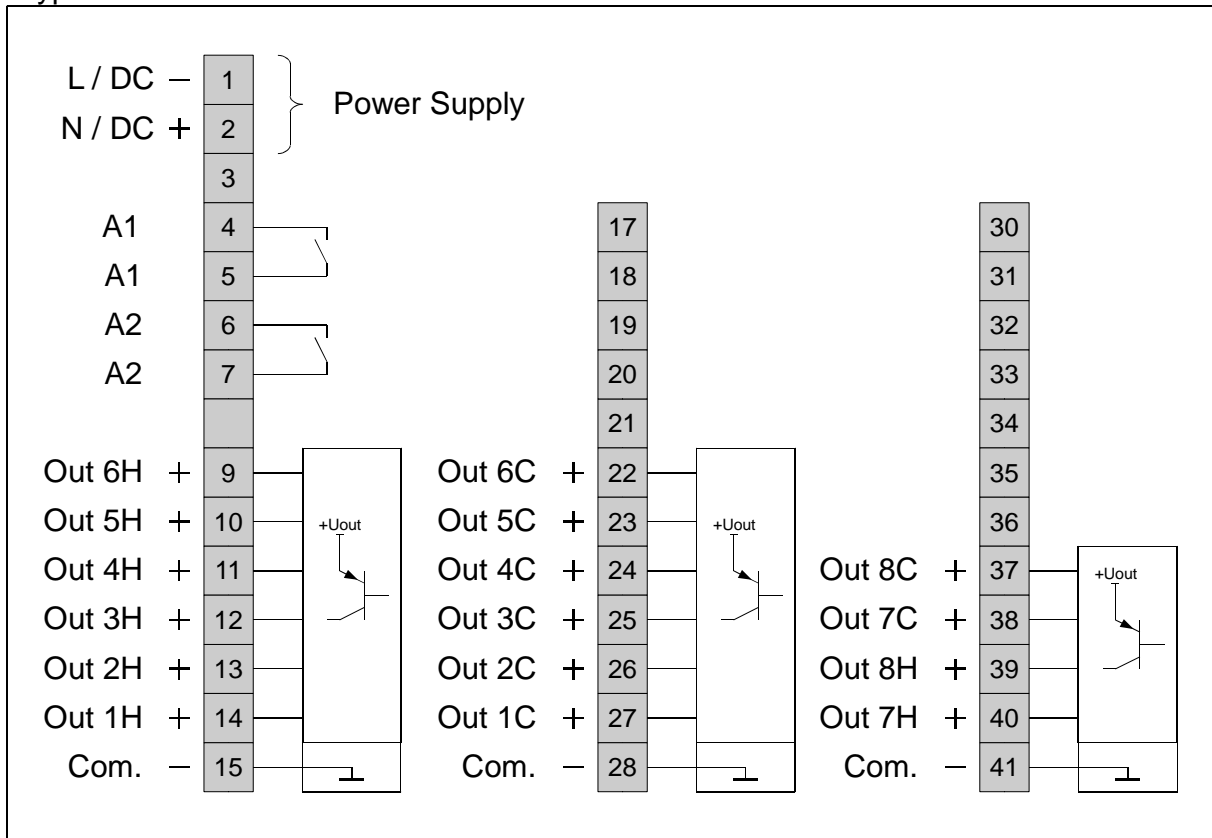

Type: 837

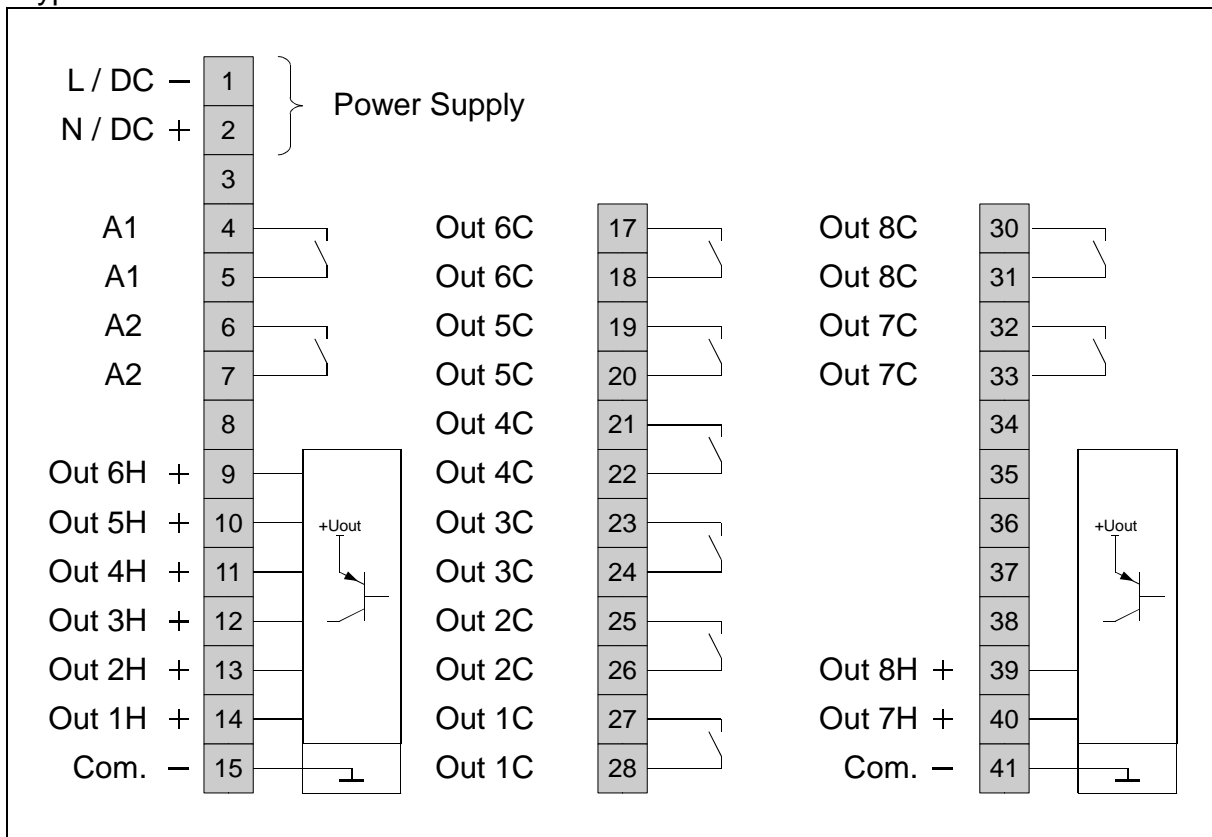

5.2 Sensor Inputs

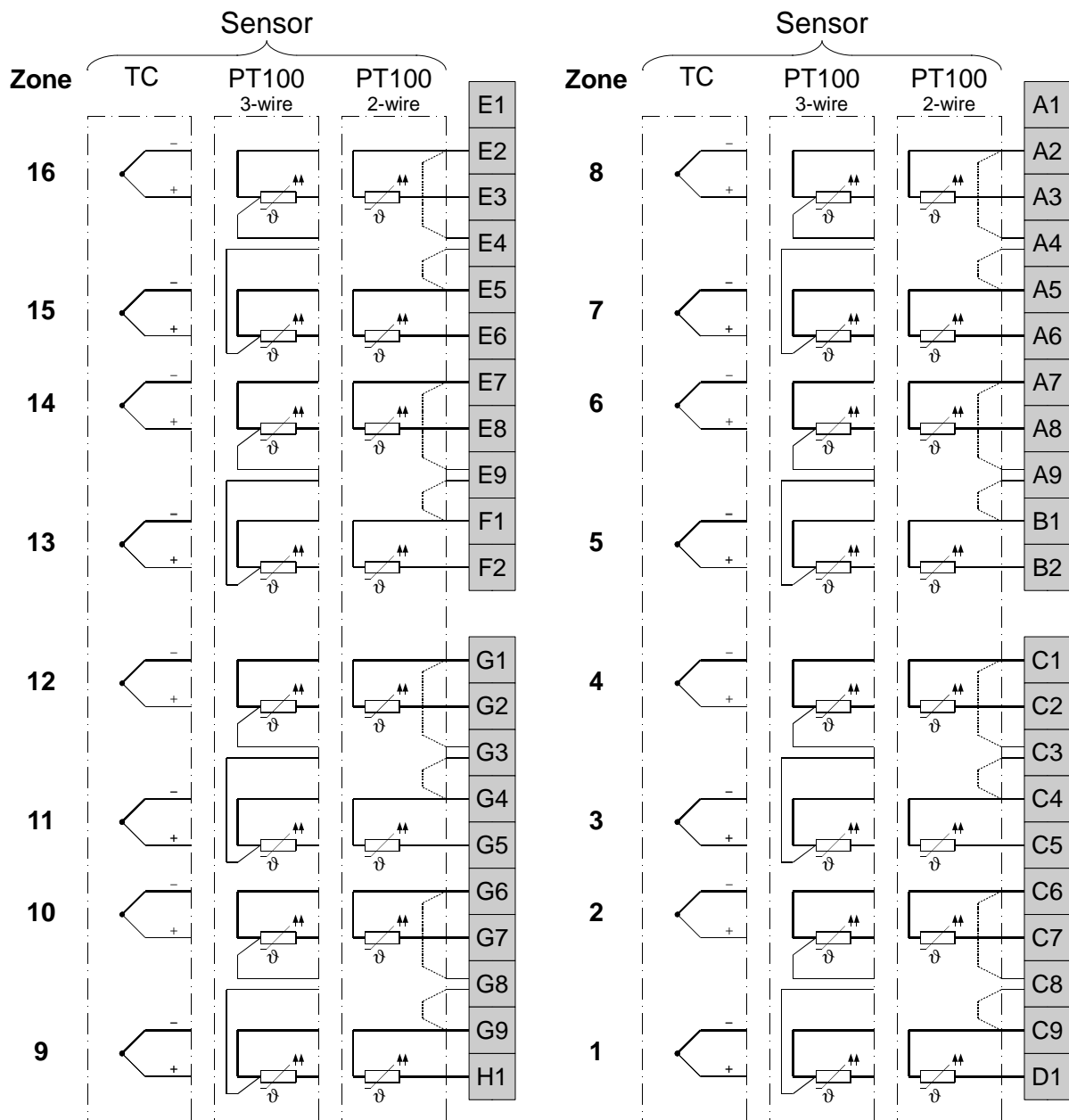

It is not permitted to connect the grounds of the sensor-inputs and Logic-outputs with each other.

5.3 Additional Functions

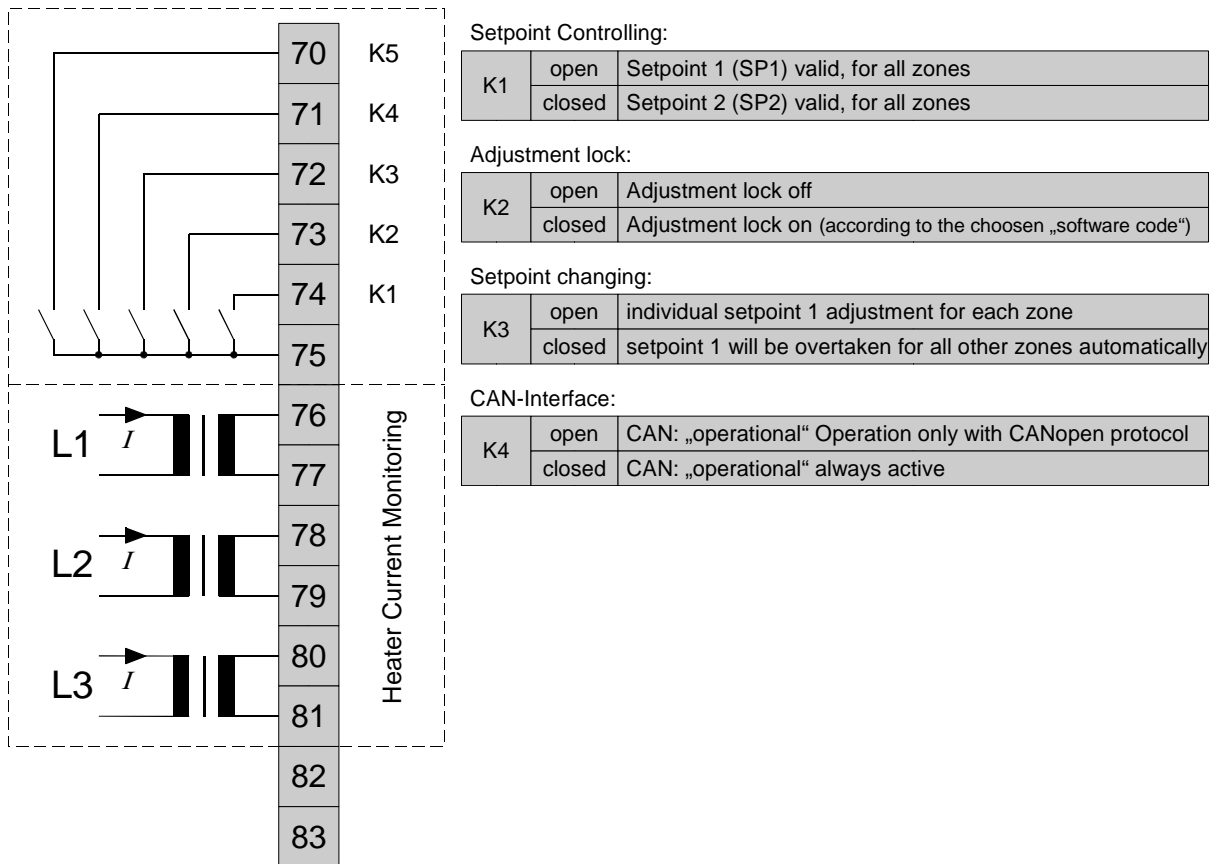

5.4 Fieldbus Interfaces

Profibus	CAN	RS 485	RS 232	0/20mA	
GND			GND		90
VP +5V			RxD out	RxD in	91
CNTR			TxD in	RxD out	92
RxTx P	H	A	TxD out	TxD out	93
RxTx N	L	B	RxD in	TxD in	94
Service-Interface RS 485				A	95
				B	96

6 Display and Keyboard

The device is equipped with a backlight LC-display.



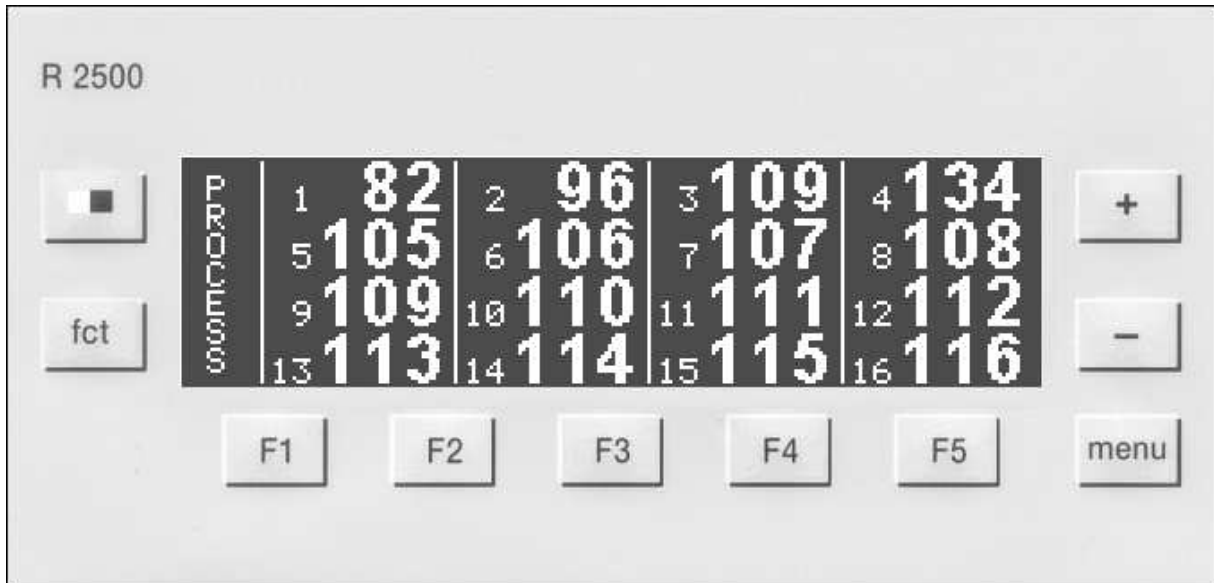

After switching on the device will initialize.

The actual process values of all connected zones are displayed.

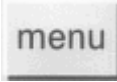
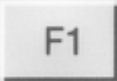
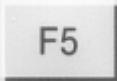

The device is operated by menus. The different parameters are displayed mainly in clear and can be displayed in various languages.

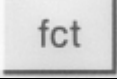
Key functions:

	Switching to the main menus. Two menus are available for display and parameter windows.
 ... 	Softkeys. The functions of these keys vary according to the menu line above.
 	Setting of values.
	Key for special functions
	Setting the display contrast: Keep pressing the key and set the contrast by "+" or "-".

6.1 Menu 1: Display Windows

Menu 1 offers various windows for the visualisation of the control process:
The different windows can be selected by pressing the respective function keys.

F1: Actual process values: The actual process values of all zones are displayed.

PROCESS	1	96	2	102	3	104	4	111
	5	105	6	106	7	107	8	108
	9	109	10	110	11	111	12	112
	13	113	14	Er.L	15	Er.H	16	

Zone 13:

Actual process
value 113 °C

Zone 14:

Sensor error:
lower than
measuring range

Zone 15:

Sensor error:
higher than
measuring range

Zone 16:

Zone switched off

F2: Display of all actual process values and setpoints with possibility of setting

ZONE	1	2	3	4	5	6	7	8
PROCESS	96	102	104	111	105	106	107	108
SETPOINT	96	102	H22	111	105	106	107	108
ZONE	9	10	11	12	13	14	15	16
PROCESS	109	110	111	112	113	Er.L	Er.H	OFF
SETPOINT	109	110	111	112	113	114	115	116
Edit								

In the SETPOINT line the actual setpoint (SP1 or SP2) or the manual output ratio is displayed
(e.g. H22 = 22 %)

In the PROCESS line the actual process value, sensor errors (Er. H or Er. L) or the off-modus (OFF)
is displayed.

After pressing key F5 (Edit) the setpoint or the manual output ratio can be set.



Select the zone by F1 and F2.

For saving press key F5 (Enter) or select the next zone.

If the setpoint 2 is active in a zone, it cannot be set in this window.

F3: Tendency Display and Alarm Display

Here the temperature tendency and alarms A1 and A2 are displayed. The display allows a quick overview of the temperature relations in all zones.

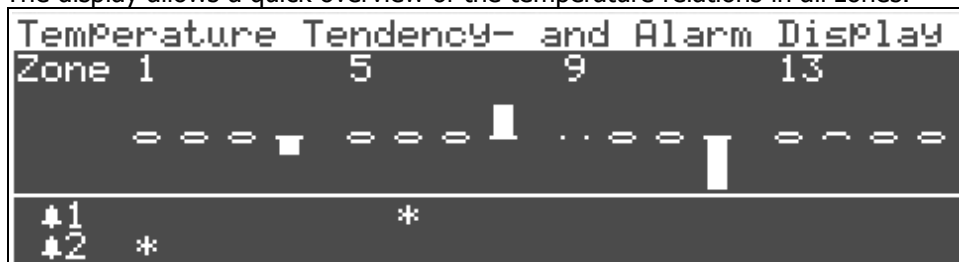

Examples:

- Zone 1: Process in balance, alarm 2 active.
- Zone 4: Actual process value is lower than setpoint (approx. 1% of the measuring range).
- Zone 6: Process in balance, alarm 1 active.
- Zone 8: Actual process value is higher than setpoint (approx. 2% of measuring range).
- Zone 9: Switched off.
- Zone 12: Actual process is lower than setpoint (< 3% of measuring range).

If the option "heater current monitoring" has been activated and continuous current flow (short circuit of the semiconductor switches) is detected, "Permanent current detected" is displayed.

F3: Process overview

Zone	Temp.	Set	Y%	-A-	Amp.	Info
1	82.3	96.3	100*	2	0.0	
2	96.0	98.0	0		0.0	Opt
3	109.0	110.0z	13		0.0	
4	13.0	140.0	0		0.0	Ramp

Temp Display of actual process value	82.3 OFF Er.H Er.L	Process value Zone switched off Sensor break, higher than measuring range Short circuit of sensor, lower than measuring range
Set Setpoint display	Man. XX2	Zone is working with manual output ratio. Setpoint 2 is active.
Y% Output ratio	*	The asterisk indicates that the output is momentarily switched on.
-A- Alarm display	1 2 A	Alarm 1 is active. Alarm 2 is active. Heater current monitoring: Short circuit/Permanent current
Amp. Current display		Actual heater current [A]. The value is only visible if a heater current monitoring alarm has been programmed.
Info Status display	Opt Ramp E.xx	Autotune active Setpoint ramp active. Press the key „fct“ to display the actual ramp setpoint: 37.0r Error message (can be confirmed by F3)

By the keys F4 and F5 the next respectively the previous four zones can be selected.

6.2 Menu 2: Configuration Windows

Menu 2 offers various windows for configuring and monitoring the controller:
The different windows can be selected by pressing the respective function keys.

F1: Control Parameters. Setting required for each zone.

ZONE	1	2	3	4
SetPoint 1	90.0	300	95	140
SetPoint 2	off	off	110	off
Rising ramp	off	off	off	20.0
Falling ramp	off	off	off	off
Alarm value #1	off	off	off	off

← Zone ▲ Parameter ▼ Edit

By the keys "F1" and "F2" (Zone) the zone can be selected.

By the keys "F3" and "F4" (Parameter) the parameter can be selected.

When pressing key "F5" (Edit), a parameter is displayed on a white background. (Cursor)

By the keys "F1" - "F4" the cursor can be set to any parameter. This parameter value may now be changed by the keys "+" and "-".

For saving set the cursor to another parameter or press key "F5" (Enter).

The number of the parameters displayed differs according to the version and configuration of the device.

For the description of the parameters see chapter: "Control Parameters. Zone Dependent"

F2: Configuration Device Parameters. Settings are valid for all zones.

Device Parameters	
PT100(RTD) / TC	Z1-16:RTD
Alarm config. #1	heater current _r#-(8)
Switch behav. #1	direct
Alarm config. #2	limit contact _r#-(2)
Switch behav. #2	direct

▲ Parameter ▼ Edit

By the keys "F3" and "F4" (Parameter) the parameter can be selected.

When pressing key "F5" (Edit), a parameter is displayed on a white background. (Cursor)

By the keys "F3" - "F4" the cursor can be set to any parameter. This parameter value may now be changed by the keys "+" and "-".

For saving please set the cursor to another parameter or press key "F5" (Enter).

For the description of the parameters
see chapter: "Configuration Parameters, Valid for the Complete Device"

F3: Recorder Function

Display of temperature gradation over time for the selected zone

Select recorder function by pressing "fct" in the window "Zone Information".

Leaving the recorder function: Press key "fct" again.

This function enables the user to observe the transient response and the timing behaviour of the controller for the selected zone and to set parameters accordingly.

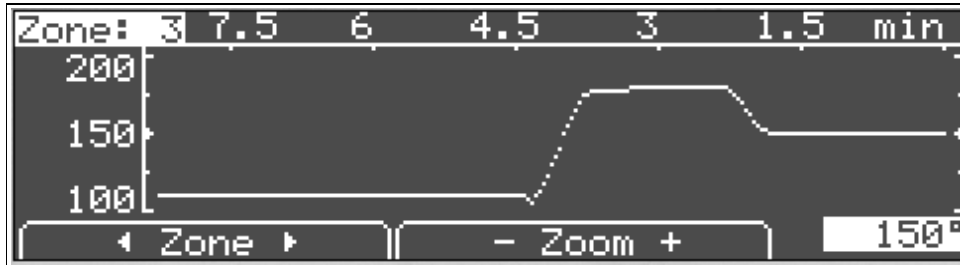

In the event of an error, the course taken by the actual value prior to the occurrence can be retrospectively examined.

The actual value is always displayed symmetrically relating to the current setpoint. At the bottom right the actual process value is shown.

By the keys "F1" and "F2" (Zone) the zone can be selected.

By the keys "F3" and "F4" (Zoom) the resolution of the temperature axis can be changed.

F3: Device Status

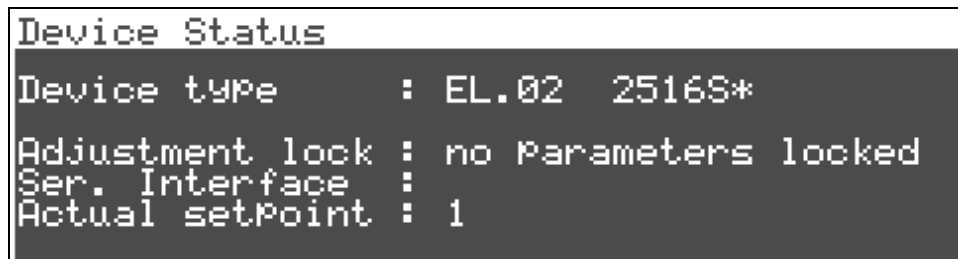

Display for general information about the device:

Type of device, firmware version (e.g EL.02), mode of adjustment lock and selected setpoint.

In the line "Ser. Interface" information about the Fieldbus-Interface is displayed.

In case of a serial interface and CANopen the word "DATA" is indicated after every successful communication for a short time.

When using Profibus, the bus status is displayed in clear:

```
no connection
wait param.
data exchange
```

7 Parameter Descriptions

7.1 Configuration Parameters, Valid for the Complete Device

<p>PT100 / Thermo.</p>	<p>Selecting the kind of sensor for each zone. The zones can be configured in pairs of PT100 or thermocouple (TC):</p> <p>Example: Z1-16:TC All zones thermocouple Z1-2:TC Z3-16:RTD Zone 1-2 thermocouple Z1-16:RTD All zones PT100 <§> For selecting the sensor type see chapter " Zone Configuration".</p>
-------------------------------	---

Alarm configurations, general information:

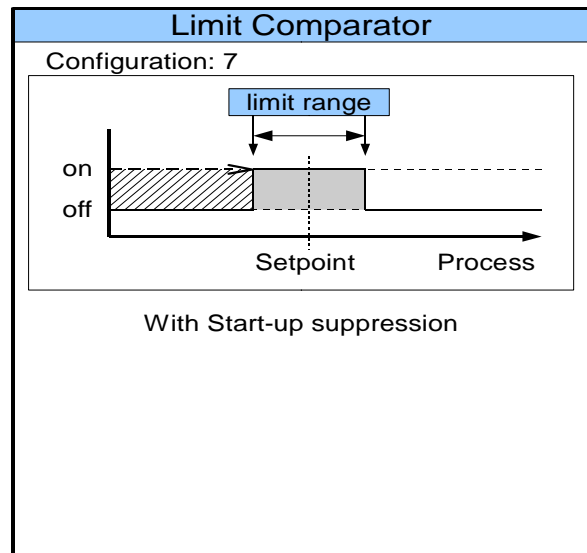
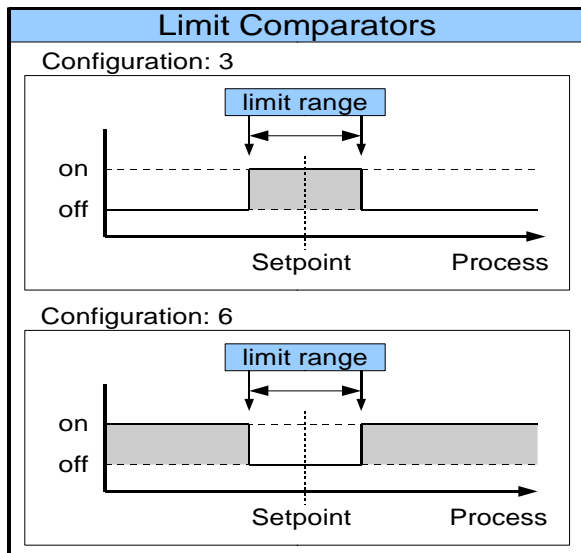
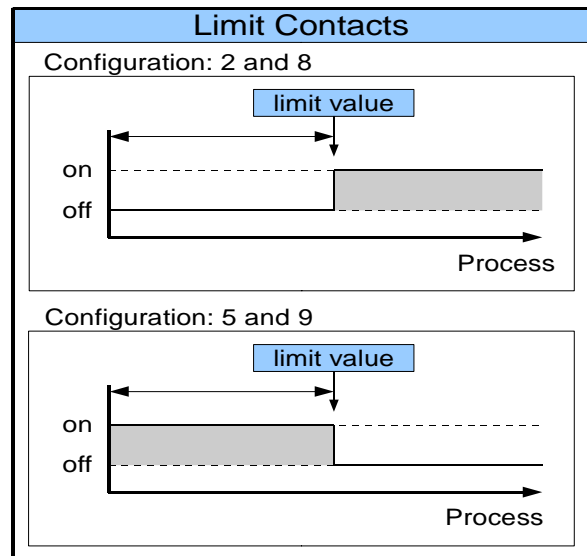
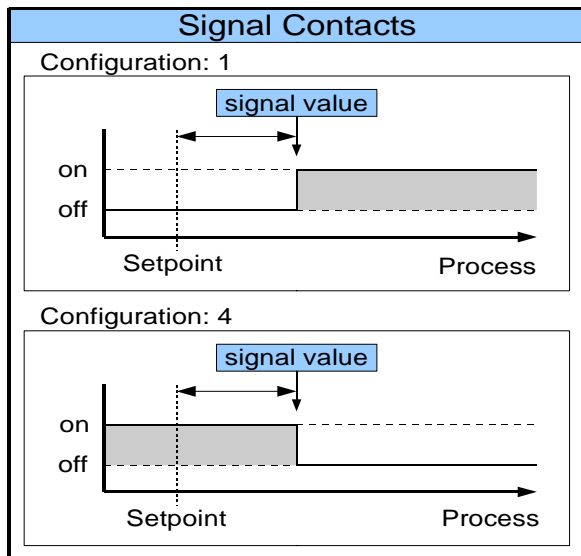

The controller features two independent alarms with one corresponding alarm relay each.

Each alarm contact works as a common alarm for all zones. The individual alarms A1 (A2) of all zones are connected to the common contact A1 (A2). The selected configuration is valid for all active zones

Please note:

Care should be taken to ensure that the setpoints of the alarm contacts are programmed within the selected measuring range.

If a setpoint ramp has been programmed, the alarms that are relative to the setpoint (signal contact, limit comparator) follow the setpoint ramp.

In case of sensor error the alarms react in the same way as range override.

The alarm contacts therefore do not offer protection against all types of plant breakdown.

We recommend the use of a second, independent monitoring unit.

The different alarm configurations define the working mode of the alarm. If the controller features a heater current monitoring, two additional heater current alarms are available. The actual alarm values have to be set in the menu "Control Parameters".

<p>Alarm config. A1 Alarm configuration Contact A1</p>	<p>alarm off (0) <S> signal contact $_ \bar{\mathbf{A}}_$ (1) limit contact $_ \bar{\mathbf{A}}_$ (2) limitcompar. $_ \bar{\mathbf{A}} _$ (3) Limit comparator signal contact $\bar{\mathbf{A}} _$ (4) limit contact $\bar{\mathbf{A}} _$ (5) limitcompar. $\bar{\mathbf{A}} _ \bar{\mathbf{A}}_$ (6) Limit comparator lim comp ssup $_ \bar{\mathbf{A}} _$ (7) Limit comparator with start-up suppression heater current $_ \bar{\mathbf{A}}_$ (8) Heater current limit contact heater current $\bar{\mathbf{A}} _$ (9) Heater current limit contact</p>
<p>Switch behav. A1 Relay switching behaviour</p>	<p>Here the relay function may be inverted: direct The relay is switched on if the controller displays an alarm message. <S> inverse The relay is switched off if the controller displays an alarm message.</p>
<p>Alarm config. A2 Alarm configuration Contact A1</p>	<p>Identical adjustment as Alarm config. A1</p>
<p>Switch behav. A2 Relay switching behaviour</p>	<p>Identical adjustment as Switch behav. A1</p>

Heater current monitoring (option)

The heater current monitoring function is valid for all connected zones.
The following parameters are displayed when the alarm configuration is programmed to "heater current" (8 or 9).

The alarm value (heater current value) is programmed as an absolute value.

Please note: Ensure that the limit value is set correctly to avoid false alarms in case supply voltage changes. The alarm can be delayed by selecting a "Delay time".

The heater current measuring is designed for a current transformer 1:1000.
(ELOTECH type: M2000)

Heater current detection and indication range:

0...max. 60,0 A Single-phase operation

0...max. 99,9 A Three-phase operation

The sum of all three phases currents is monitored.

Current det.cycle	1...60s <§ = 2s> Time interval between the current measurement of two successive zones
Delay time A1	5 steps adjustable, unit: seconds The values depend on the current detection cycle time and the number of active controller zones. off = no delay time active <§>
Delay time A2	5 steps adjustable, unit: seconds The values depend on the current detection cycle time and the number of active controller zones. off = no delay time active <§>
Min leak.Current Monitoring concerning an impermissible permanent current	off<§>, 0,0...99,9 A The sum of the actual leakage current will be displayed as "Act leak-curr." SSRs (especially if they are combined with RC-combinations) normally have small leakage currents. A leakage current limit value is programmable. All values below this limit will not be considered in the alarm monitoring. If a permanent current is detected the alarm will be activated. The status is displayed in the window "Tendency Display": „Permanent current detected“. The zone with a permanent current can be detected by observing the actual process values (high values).
Current transformer: Turns ratio	1:100 ... 1:9999 < § = 1:1000 for M2000 >

Adjustment lock	no parameters locked	All parameters adjustable<§>
	only setpoint 1 free setp./alarm/ramp free all parameters locked	All other parameters are locked. Setpoints, alarm values and ramps are adjustable. All other parameters are locked. No parameter is adjustable.
The parameters that have been locked can be displayed but not changed. This adjustment cannot be changed if the external contact K2 is closed.		
Zones offset	off<§>, 1...83 The adjusted offset value is added to the displayed zone numbers in the windows. Therefore a continuous numbering of the zones can be achieved if more than one device is used. Examples: offset = off: zones numbering: 1-16 offset = 16: zones numbering: 17-33	

Serial Interface (RS232, RS485 or TTY)

The controllers of the series **R2400** can be equipped with a serial interface **RS232, RS485** or **0/20mA** (half-duplex) as an option.

This enables a master (PLC) to set and to read the process- and configuration parameters. The communication is always controlled by the master. The controller operates as a slave. If there are transmission or range errors detected by the slave, the message is not accepted and the existing parameter values remain valid.

In Menu 2 -> Device status, Line „Ser. Interface“ the activity of the data communication is displayed. After a successful communication the word "Data" is shown for a short time.

It is not possible to operate the device by keyboard if it is set to remote-operation by the master.

Protocol descriptions and further information: Please see www.elotech.de/downloads

Protocol select.	Standard Elotech Modbus Standard ELOTECH protocol <§> Modbus- RTU protocol
Device address	1<§>... 255 1<§>... 247 (Modbus-RTU-Protocol) At this address a master communicates with the controller. Each controller needs a unique address.
Data format	Adjusting the data format for the transmission: 7E1 7 databit, even parity, 1 stopbit 7o1 7 databit, odd parity, 1 stopbit 7E2 7 databit, even parity, 2 stopbit 7o2 7 databit, odd parity, 2 stopbit 7n2 7 databit, no parity, 2 stopbit 8E1 8 databit, even parity, stopbit 8o1 8 databit, odd parity, 1 stopbit 8n1 8 databit, no parity, 1 stopbit 8n2 8 databit, no parity, 2 stopbit
Baud rate	off Interface inactive 300 baud 600 baud 1.2 kbaud 2.4 kbaud 4.8 kbaud 9.6 kbaud <§> 19.2 kbaud 38.4 kbaud

Profibus Interface

The following parameters are visible if the device is equipped with a Profibus-DP-interface (option).

This enables a master (PLC) to set and to read the process- and configuration parameters. The communication is always controlled by the master. The controller operates as a slave. If there are transmission or range errors detected by the slave, the message is not accepted and the existing parameter values remain valid.

In Menu 2 -> Device status, Line „Profibus“:the status of the interface is displayed.

no connection	Profibus not connected or master inactive
wait param.	Master detected – device expects initialization
data exchange	Data Exchange Mode

By Profibus all process values and configuration parameters can be read at any time. If the master wants to write parameters to the controller, the parameter "**Remote**" has to be set to "on".

Protocol descriptions and further information: Please see www.elotech.de/downloads

Remote	off Keyboard operation permitted, Profibus can read only. on Keyboard operation locked (display REMO), Profibus can read and write.<§>
Device address	1<§>... 125 At this address a master communicates with the controller. Each controller needs a unique address.
Baud rate	The baud rate will be detected and only displayed automatically. It is not adjustable. Supported baud rates: 12 Mbaud 6 Mbaud 3 Mbaud 1.5 Mbaud 500 kbaud 187.5 kbaud 93.75 kbaud 45.45 kbaud not detected No valid baud rate detected.

CANopen Interface

The following parameters are visible if the device is equipped with a CANopen interface. (option)

This enables a master (PLC) to set and to read the process- and configuration parameters.

In Menu 2 -> Device status, Line „CANopen“ the activity of the data communication is displayed. After a successful communication the word "Data" is shown for a short time.

The control operation will start when the controller is set into "operational mode" by the CANopen-master. In this case the keyboard is locked.

For control operation without CAN-interface close contact K4.

Note: A CAN-network has to be terminated on both ends with terminating resistors (120 Ohm).

CANopen-specification	CANopen Master:	no
	CANopen Slave:	yes
	Extended Boot-up:	no
	Minimum Boot-up:	yes
	COB ID Distribution:	yes; default via SDO
	Node ID Distribution:	no; via device keyboard
	No. of PODs:	0RX, 1TX
	PDO Modes:	async.
	Variable PDO mapping:	no
	Emergency message:	yes
	Life guarding:	yes
	No. of SDO`s:	1RX, 1TX
	Device Profile:	CiA DS-404

Protocol descriptions and further information: www.elotech.de/Downloads

Device address	1<§>... 127 At this address a master communicates with the controller. Each controller needs a unique address.
Baud rate	20 kbaud <§> 50 kbaud 100 kbaud 125 kbaud 250 kbaud 500 kbaud 1000 kbaud

SERVICE Interface: Device address	See chapter „Service interface“ 1...247 <§ = 1>
Sample time (Recorder function)	Time difference between two successive process value samples. In brackets: the total time period which can be monitored 2,5s (total: 8,3min) 5s (total: 16,7min) 10s (total: 33,3min) <§> 30s (total:100,0min) 1min (total: 3,3h) 5min (total:16,7h) 10min (total:33,3h) Up to 200 temperature values can be stored.
Language	Adjusting the language for the operator guidance. German <§> English

End of the Configuration Parameters list

7.2 Control Parameters, Zone Dependent

Setpoint 1	Programming range: Setpointlimit min..Setpointlimit max <§ = 0°C>
Setpoint 2	off<§>,Setpointlimit min..Setpointlimit max If the external contact K1 is closed, the setpoint 2 becomes active in all zones in which Setpoint 2 is not set to "off".

Ramp function:

A programmed ramp is always activated when the setpoint is changed or when the mains supply is switched on. The ramp starts at the actual process value and ends at the preselected setpoint. The ramp can be activated for both setpoint 1 and setpoint 2. By programming the second setpoint accordingly a setpoint profile can be obtained.(Please see example below.)

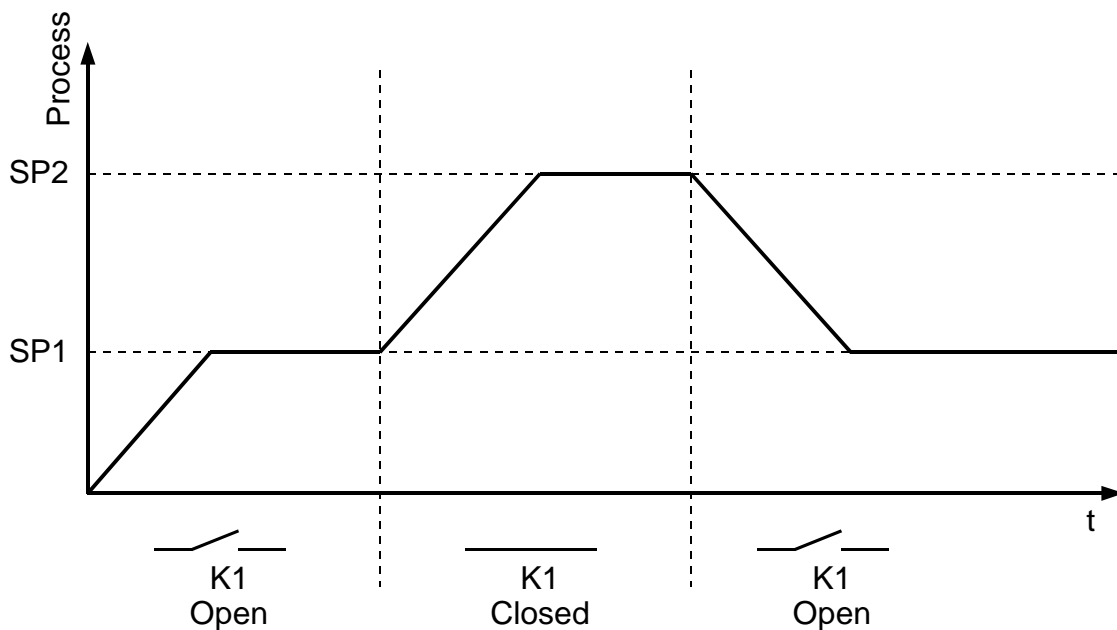

Rising ramp	off<§>, 0,1 ... 99,9	°C/min or °F/min for measuring range without decimal point
	off<§>, 0,01 ... 9,99	°C/min or °F/min for measuring range with decimal point
Falling ramp	off<§>, 0,1 ... 99,9	°C/min or °F/min for measuring range without decimal point
	off<§>, 0,01 ... 9,99	°C/min or °F/min for measuring range with decimal point

Alarm value 1 switches relay A1	Before adjusting an alarm value, the alarm configuration has to be set.	
	Temperature monitoring:	
	off<§>, -199...199	Signal contact, without decimal point
	off<§>, -19,9...19,9	Signal contact, with decimal point
	off<§>, 1... 199	Limit comparator, without decimal point
	off<§>, 0,1... 19,9	Limit comparator, with decimal point
	off<§>, Measuring range, bottom end ... top end	Limit contact, adjustment according to measuring range
	Heater current monitoring:	
	off<§>, 0,1...99,9 A	Limit contact
Alarmvalue 2 switches relay A2	Identical setting as Alarm value 1	
Max output Ratio (heating)	0%...100%<§ > The limitation of the output ratio is only necessary if the heating energy supply is grossly overdimensioned compared to the power required. Under normal conditions a limitation is not necessary (setting = 100%). The limitation becomes effective when the controller's calculated output ratio is greater than the maximum permissible (limited) ratio. Warning! The output ratio limitation does not work during autotune.	

Adjustment of the control parameters:

As standard the controller operates in PD/I control mode, i. e. controlling without deviation and with practically no overshoot during start-up.

3-point controllers (>3<) have a second "cooling" parameter set.

The control action can be altered in its structure by adjusting the following values to the parameters:

- a. no control action, on-off setting P = off
- b. P-action setting D and I = off
- c. PD-action setting I = off
- d. PI- setting D = off
- e. PD/I modified PID-mode (set: P, D, I)

According to the configuration, certain parameters are not visible.

P <P-band> (%) Proportional band	off, 0.1 ... 100.0% <§=3.0>
D <rate time>(s) Rate time	off, 1 ... 200s <§=30>
I <reset time>(s)	off, 1 ... 1000s <§=150>
Cycle time	0,5...240,0 s <§=10,0> The switching frequency of the actuator can be determined by adjusting the cycle time. In this time interval the controller switches on and off once. Voltage outputs for SSRs: cycle time: 0,5...10 s Optimal value for fast control loops: 0,8s Relay outputs: cycle time > 10 s The cycle time should be set as long as possible to minimize the wear of relay contacts

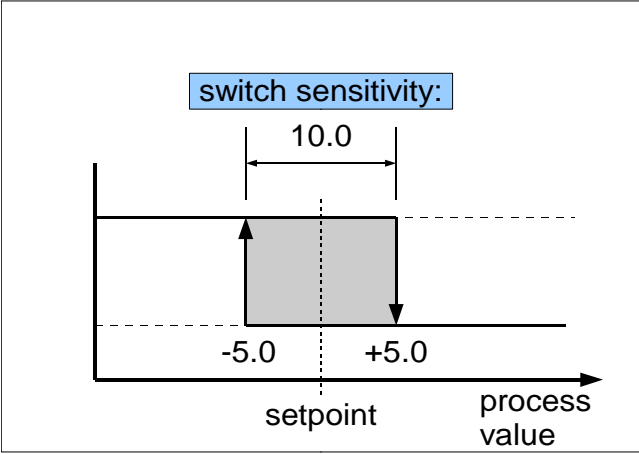
<p>Switch sensitivit</p>	<p>Only if „P- Band“ = off (on-off action, without feedback) off; 0,1<§>...80,0 for range without decimal point off; 0,01<§>...8,00 for range with decimal point</p> 
<p>Deadband h<->c</p>	<p>Off; 0,1<§>...80,0 for range without decimal point off; 0,01<§>...8,00 for range with decimal point If the controller is in heating mode, the actual process value has to rise by the adjusted value above the setpoint before the cooling mode will become active. By this the switching frequency between the heating and cooling outputs can be reduced. >3< Simultaneous activation of heating and cooling outputs is not possible.</p>
<p>max outp. ratio c</p>	<p>0%...100%<§ > The limitation of the output ratio is only necessary if the heating or cooling energy supply is grossly overdimensioned compared to the power required. Under normal circumstances no limitation is needed (setting = 100%). The limitation becomes effective when the controller's calculated output ratio is greater than the maximum permissible (limited) ratio. Warning! >3< The output ratio limitation does not work during autotune.</p>
<p>P <P-band> c (%) Proportional band cooling >3<</p>	<p>off, 0.1 ... 100.0% <§=3.0></p>
<p>D <rate time> c Rate time cooling >3<</p>	<p>off, 1 ... 200s <§=30></p>
<p>I <reset time> c Reset time cooling >3<</p>	<p>off, 1 ... 1000s <§=150></p>
<p>Cycle time c Cycle time cooling >3<</p>	<p>0,5...240,0 s <§=10,0> The switching frequency of the actuator can be determined by adjusting the cycle time. This is the total time needed for the controller to switch on and off once. Bistable voltage outputs: cycle time 0,5...10 s / optim. = 0,8s. Relay outputs: cycle time > 10 s The cycle time should be set as long as possible to minimize the wear of relay contacts.</p>

Switch sensitivity c
Switch sensitivity cooling

Only if „P- Band“ = off (on-off action, without feedback)
off; 0,1<math>\\$>\dots 80,0 for measuring range without dec. point
off; 0,01<math>\\$>\dots 8,00 for measuring range with decimal point

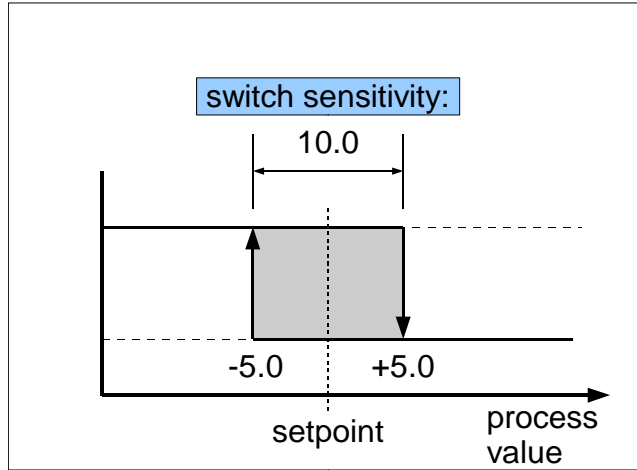

Autotune:

The tuning algorithm determines the characteristic values within the controlled process and calculates the valid feedback parameters (P,D,I) and the cycle time (= 0.3 x D) of a PD/I-controller for a wide section of the range.

The autotune mode is activated during start-up shortly before the setpoint is reached.

If activated after the setpoint has already been reached, the temperature will first drop by approx. 5% of the measuring range in order to detect the exact amplification of the process.

Autotune active: Indication in display "Zone Information": OPT

The tuning algorithm can be activated at any time by selecting the parameter **Autotune = on**. After having calculated the feedback parameters, the controller will lead the process value to the actual setpoint.

Selecting **Autotune = off** will stop the autotune function.

Conditions for starting the Autotune algorithm:

- The setpoint must amount to at least 5% of the measuring range.
- The sensor must not have a failure.
- The softstart function must not be active.

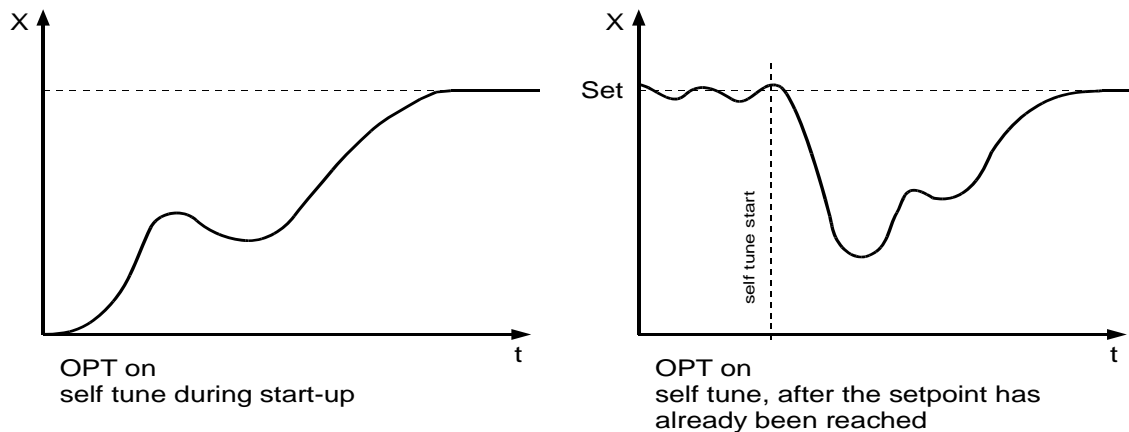

Autotune	off	autotune / self tuning out of action<§>
	on	autotune / self tuning active
	all	<+Vers EL.02A> Autotune is started for all zones meeting the required conditions for the autotune algorithm. The function "all zones" is not supported by the fieldbus interfaces.
Process offset	<p>- 999...off<§>...1000 for measuring range without decimal point</p> <p>- 9,9...off<§>...10,0 for measuring range with decimal point</p> <p>This parameter serves to correct the input signal, e.g. for:</p> <ul style="list-style-type: none"> - the correction of a gradient between the measuring point and the sensor tip - the line resistance balancing of 2-line RTD (Pt100) sensors - correction of the control deviation when using P- or PD-action <p>If for example the offset value is set to +5°C, the real temperature measured by the sensor (when process is balanced) is 5 °C less than the setpoint and the displayed actual process value. Make sure that the corrected temperature process value does not leave the selected measuring range.</p>	

Zone on/off	on Measuring- or controller zone active <§> off Measuring- or controller zone switched off																																																																										
Controller config Controller configuration	2P h 2-point controller "heating-off" <§> 2P c 2-point controller "cooling-off" 2Pnc 2-point controller "cooling non linear". Cooling action with non-linear cooling response curve (e.g. for vapour cooling). 3P 3-point-controller "heating-off-cooling" >3< 3Pnc 3-point-controller "heating-off-cooling". Cooling action with non-linear cooling response curve (e.g. for vapour cooling). >3< disp Indicator, no controller action																																																																										
Sensor selection	If the zone is configured to PT100, the following sensors are available: <table border="1"> <tr> <td>P1 °C</td> <td>Pt 100,</td> <td>0,0 ... 99,9 °C</td> <td></td> </tr> <tr> <td>P1 °F</td> <td>Pt 100,</td> <td>32 ... 212 °F</td> <td></td> </tr> <tr> <td>P2 °C</td> <td>Pt 100,</td> <td>-100 ... 200 °C</td> <td></td> </tr> <tr> <td>P2 °F</td> <td>Pt 100,</td> <td>-148 ... 392 °F</td> <td></td> </tr> <tr> <td>P4 °C</td> <td>Pt 100,</td> <td>0...400 °C</td> <td><§></td> </tr> <tr> <td>P4 °F</td> <td>Pt 100,</td> <td>32...752 °F</td> <td></td> </tr> <tr> <td>P8 °C</td> <td>Pt 100,</td> <td>0...800 °C</td> <td></td> </tr> <tr> <td>Ni °C</td> <td>Ni120,</td> <td>0...250 °C</td> <td></td> </tr> <tr> <td>Ni °F</td> <td>Ni120,</td> <td>32...482 °F</td> <td></td> </tr> </table> If the zone is configured to thermocouple, the following sensors are available: <table border="1"> <tr> <td>L4 °C</td> <td>T/C</td> <td>Fe-CuNi (L), 0...400 °C</td> <td></td> </tr> <tr> <td>L4 °F</td> <td>T/C</td> <td>Fe-CuNi (L), 32...752 °F</td> <td></td> </tr> <tr> <td>L8 °C</td> <td>T/C</td> <td>Fe-CuNi (L), 0...800 °C</td> <td></td> </tr> <tr> <td>J8 °C</td> <td>T/C</td> <td>Fe-CuNi (J), 0...800 °C</td> <td></td> </tr> <tr> <td>K1 °C</td> <td>T/C</td> <td>NiCr-Ni (K), 0...999 °C</td> <td></td> </tr> <tr> <td>N1 °C</td> <td></td> <td>NiCrSi-NiSi (N), 0...999°C</td> <td></td> </tr> </table> Please note: If the sensor selection is changed, the following parameters will be reset: <table border="1"> <tr> <td>Setpoint 1, Setpoint 2:</td> <td>Setpoint limitation min.</td> </tr> <tr> <td>Lower setpoint limitation:</td> <td>measuring range bottom</td> </tr> <tr> <td>Higher setpoint limitation:</td> <td>measuring range top</td> </tr> <tr> <td>Setpoint ramp rising/falling:</td> <td>off</td> </tr> <tr> <td>Alarm values:</td> <td>off</td> </tr> <tr> <td>Actual process value offset:</td> <td>off</td> </tr> </table>			P1 °C	Pt 100,	0,0 ... 99,9 °C		P1 °F	Pt 100,	32 ... 212 °F		P2 °C	Pt 100,	-100 ... 200 °C		P2 °F	Pt 100,	-148 ... 392 °F		P4 °C	Pt 100,	0...400 °C	<§>	P4 °F	Pt 100,	32...752 °F		P8 °C	Pt 100,	0...800 °C		Ni °C	Ni120,	0...250 °C		Ni °F	Ni120,	32...482 °F		L4 °C	T/C	Fe-CuNi (L), 0...400 °C		L4 °F	T/C	Fe-CuNi (L), 32...752 °F		L8 °C	T/C	Fe-CuNi (L), 0...800 °C		J8 °C	T/C	Fe-CuNi (J), 0...800 °C		K1 °C	T/C	NiCr-Ni (K), 0...999 °C		N1 °C		NiCrSi-NiSi (N), 0...999°C		Setpoint 1, Setpoint 2:	Setpoint limitation min.	Lower setpoint limitation:	measuring range bottom	Higher setpoint limitation:	measuring range top	Setpoint ramp rising/falling:	off	Alarm values:	off	Actual process value offset:	off
P1 °C	Pt 100,	0,0 ... 99,9 °C																																																																									
P1 °F	Pt 100,	32 ... 212 °F																																																																									
P2 °C	Pt 100,	-100 ... 200 °C																																																																									
P2 °F	Pt 100,	-148 ... 392 °F																																																																									
P4 °C	Pt 100,	0...400 °C	<§>																																																																								
P4 °F	Pt 100,	32...752 °F																																																																									
P8 °C	Pt 100,	0...800 °C																																																																									
Ni °C	Ni120,	0...250 °C																																																																									
Ni °F	Ni120,	32...482 °F																																																																									
L4 °C	T/C	Fe-CuNi (L), 0...400 °C																																																																									
L4 °F	T/C	Fe-CuNi (L), 32...752 °F																																																																									
L8 °C	T/C	Fe-CuNi (L), 0...800 °C																																																																									
J8 °C	T/C	Fe-CuNi (J), 0...800 °C																																																																									
K1 °C	T/C	NiCr-Ni (K), 0...999 °C																																																																									
N1 °C		NiCrSi-NiSi (N), 0...999°C																																																																									
Setpoint 1, Setpoint 2:	Setpoint limitation min.																																																																										
Lower setpoint limitation:	measuring range bottom																																																																										
Higher setpoint limitation:	measuring range top																																																																										
Setpoint ramp rising/falling:	off																																																																										
Alarm values:	off																																																																										
Actual process value offset:	off																																																																										
Setpointlimit max.	Highest adjustable setpoint value <§= 400 °C> programming range: Setpointlimit min. ... top range																																																																										
Setpointlimit min.	Lowest adjustable setpoint value <§ = 0 °C> programming range: bottom range ... Setpointlimit max.																																																																										

Softstart Function in General:

If you select the softstart function, make sure that the instrument is equipped with bistable voltage (logic) outputs. This function is not allowed for instruments with relay outputs. Otherwise the relays will be damaged.

During the softstart the controller's heating output response is limited to a preselected ratio, in order to achieve a slow drying of high performance heat cartridges. This results in a slower, more regular heating period. Simultaneously the output clock frequency is quadrupled.

Once the process value reaches the softstart setpoint, it remains stable at this value for the preselected duration time.

At the end of this period the process value rises to the valid setpoint.

If the softstart is active, the controller's autotune function cannot operate (E.OP).

If a setpoint ramp has been programmed, the softstart has priority, and the ramp will become active after the softstart has been completed.

The softstart only works

- if the parameter P (xp) is programmed $\geq 0,1\%$
- if the actual process value is lower than the softstart setpoint – 5% of the selected measuring range

It is possible to select this function for each zone individually.

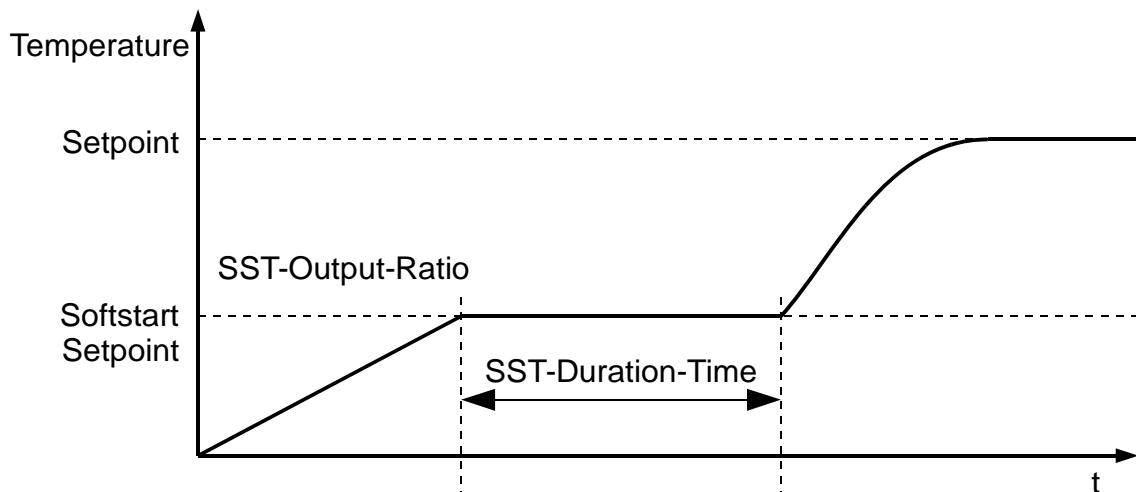

Sst softstart	off Softstart function is not active.<§> The other softstart parameters are not displayed. on Softstart function is active.
Sst output ratio	range: 10...100% <§ = 30>
Sst setpoint	range: setpoint min. setpoint max. <§ = 100>
Sst duration time	range: off, 0.1 ... 10.0 min <§ = 2.0>

Output mode	cont	Controller mode,
	auto	<p>In the event of sensor break the last valid output ratio is maintained.</p> <p>Process: Error warning: Er.H or Er.L. Setpoint: First an "H", then the actual adjustable output ratio. Particularity in display: H99 = 100 %</p> <p>Like the setpoint, the output ratio can be changed manually.</p> <p>Under the following circumstances, the output ratio will be 0%:</p> <ul style="list-style-type: none"> - if the output ratio at the time of the sensor break was 100%. - if a setpoint ramp is active. - if the control deviation was more than 0,25% of the total range at the time of sensor break. - if the Proportional-band (P) = off. - if the softstart was active at the time of the sensor break. <p>A few seconds after the sensor break has been rectified, the controller returns to automatic operation and calculates the required output ratio.</p> <p>An additional signal can be issued in the event of sensor break, if the alarm contacts are programmed accordingly.</p>
	man .	<p>The controller now operates only as an actuator. The control function (PID) is inactive.</p> <p>Process: Actual process value is shown. Display of setpoint: First an "H", then the actual adjustable output ratio. Particularity in display: H99 = 100 %</p> <p>Like the setpoint, the output ratio can be changed manually.</p>
Copy to zone	<p>The parameter set of this zone can be copied to other zones. Please note: This will only happen if the selected sensor types in the source and in the destination zone are identical.</p> <p>Set the zone number of the destination zone and confirm by enter (F5).</p> <p>If "All" is selected as destination zone, the parameters will be copied to all zones.</p> <p>The copy function may take several seconds.</p>	

End of the Control Parameters list

8 Service-Interface

The multi-zones-controllers **R2500S** are equipped with a serial service interface. It is designed to communicate with the software tool ELOVISION-2 which will allow the user to configure the controller by PC.

The following options are available:

- Read out all controller parameters.
- Modify all parameters.
- Save complete parameter sets on the PC (tool / setup management).
- Load back a setup from the PC to the controller. A once saved configuration can be copied to an unlimited number of controllers.
- Print a setup protocol.
- Visualization of all process values, setpoints and operating conditions

Interface parameters:

- Type: RS485, connection to terminal 95 (A) and 96 (B). A termination resistor (120 ohm) is required on both ends of the line!
- Baudrate: 115.2 kBaud (not adjustable) Format: 8 N 1 (not adjustable)
- Device address: Adjustable in the parameter "SERVICE interface: Device address":

When ordering the controller it has to be chosen whether the service interface is activated or not. If not ordered ex works there will be the note "not enabled" visible at the bottom of the screen. For later use of the service interface, it can be activated with the ELOVISION-2 software. Please contact the manufacturer for obtaining a licence key.

9 Error Messages

Error message	Cause	Possible remedy
LOC	Parameter has been locked.	Unlock, if need be Device parameter-> Adjustment lock
LOC EXT	Parameter has been locked by external contact K2.	Open contact K2
Er . H	Top range end has been exceeded, sensor defect	Check sensor and cable
Er . L	Bottom range end has been exceeded, sensor defect	Check sensor and cable Check process value offset
E . Op	Self tuning error	Quit error message by pressing the key "Er.Quit (F3)" Check the self tuning conditions and restart. Autotune was cancelled after a time out of 2 hours.
E . Sy	System error	Quit error message by pressing the key "Er.Quit (F3)". Check all parameters. If the error message continues, please send the controller back to the manufacturer.
E . O	System error	Please send the controller back to the manufacturer.
REMO	Adjusting or programming of parameters by keyboard is not possible. Remote-status	Profibus: Set parameter "Remote" : off Serial Interface: The master has set the controller to "Remote". CAN: The controller is in operational mode.
KONF	Adjusting of alarm values not possible. Alarm configuration: " o f f "	Set parameter "Alarm Configuration" See: Device Configuration -> Alarm Configuration

10 Technical Data

Input PT100 (RTD)	2- or 3- wire connection possible Built-in protection against sensor breakage and short circuit Sensor current: ... ≤ 1 mA Calibration accuracy: ... $\leq 0,2$ % Linear error: ... $\leq 0,2$ % Influence of the ambient temperature: ... $\leq 0,01$ % / K	
Input Thermocouple	Built-in internal compensation point and protection against sensor breakage and incorrect polarity. Re-calibration not required for a line resistance of up to 50 Ohm. Calibration accuracy: ... $\leq 0,25$ % Linear error: ... $\leq 0,2$ % Influence of the ambient temperature: ... $\leq 0,01$ % / K	
External contacts	Designed for connecting external potential-free contacts. The contact voltage (approx. 24 V DC, max. 1mA) is provided at controller terminal 75.	
Heater current monitoring	Measuring input range: 0 ... 100mA corresponding 0,0 ... 99,9A when using a current transformer 1:1000. If the value of 100mA is exceeded, the controller may be damaged.	
Control outputs	Bist. voltage signal, 0/18 V DC, max. 10 mA, short-circuit proof or Relay, max. 250 VAC, max. 3 A (resistive load)	
Alarm outputs	Relay, max. 250 VAC, max. 3 A (resistive load)	
LCD-Display	Blue STN-display with permanent, white LED-background lightening Graphic: 240 x 64 pixel Text: 8 lines with 40 characters each	
Data protection	EAROM When using a Fieldbus interface please note: Permissible writing operations per parameter must not exceed 1 000 000.	
CE-mark	Tested according to 2004/108/EG; EN 61326-1 Electrical safety: EN 61010-1	
Power supply	Depends on the version of the device: - 230 V AC, +/-10 %, 48 ... 62 Hz; approx. 10VA - 115 V AC, +/-10 %, 48 ... 62 Hz; approx. 10VA - 24 V DC, +/-25 %, approx. 10W	
Connections	Screw terminals, Protection mode IP 20 (DIN 40050), Insulation class C	
Permissible operating conditions	Operating temperature:	0 ... 50°C / 32 ... 122°F
	Storage temperature:	-30 ... 70°C / -22 ... 158°F
	Climate class:	KWF DIN 40040; equivalent to annual average max. 75 % rel. humidity, no condensation
Casing	Format, case:	192x96mm, (DIN 43700), installation depth 122 mm
	Panel cutout:	186 +1,1 mm x 92 +0,8 mm
	Format, face plate:	198x98mm
	Material:	Noryl, self-extinguishing, non-drip, UL 94-V1
	Protection mode:	IP 20 (DIN 40050), IP 50 front side
Weight	Approx. 800g ... 1100g, depends on the version of the device	
Fieldbus Interface (optically isolated)	Depends on the version of the device: - Serial: RS232, RS485, TTY (20mA) Elotech protocol, Modbus RTU - CANopen, CiA Device Profile DS-404 - Profibus DP, according to EN 50170	
Service Interface (Option):	RS485, 115,2 kBaud, 8N1	

Subject to technical improvements.

11 Notes